

Mendi

Design Iratzoki & Lizaso



Concept / Concept / Concepto	04
Modularité / Flexibility / Modularidad	06
Bien-être / Well-being / Bienestar	08
Confort / Comfort / Comodidad	10
Mobilité / Mobility / Movilidad	12
Astucieux / Smart / Inteligente	14
Convivialité / Conviviality / Acogedor	16
Collaboration / Co-working / Trabajo en grupo	18
Finitions / Finishes / Acabados	20
Modules / Modules / Módulos	21
Vidéo et App / Video and App / Video y App	23

Iratzoki & Lizaso

«Nous avons pensé MENDI comme un paysage intérieur pour les espaces de collaboration et de rencontre»

“We designed MENDI as an interior landscape for collaborative and meeting spaces”

“Hemos diseñado MENDI como un paisaje interior para espacios de colaboración y de encuentro”



Mendi

Concept

MENDI a été conçu pour accompagner l'évolution des organisations du travail et leur environnement. Le programme se destine à ces nouveaux espaces informels, ouverts et connectés, propices à l'échange et au travail collaboratif où le partage de l'information aboutit à la meilleure efficacité de l'ensemble.

Concept

MENDI has been designed to support the evolution of work organizations and their environment. The program is addressed to those new informal, open and connected spaces which contribute to greater efficiency by favouring the exchange of information and collaboration between individuals.

Concepto

MENDI ha sido diseñado para participar en la evolución de las organizaciones laborales y su entorno. El programa está dirigido a esos nuevos espacios informales, abiertos y conectados, que propician el diálogo y el trabajo colaborativo, donde el intercambio de información conduce a una mayor eficiencia colectiva.



Small

Modularité

Flexible et évolutif, MENDI propose de nombreuses solutions d'aménagement et de multiples combinaisons de modules et de couleurs, de la toute petite à la très grande composition.

Flexibility

As a flexible and progressive seating, MENDI offers both numerous design solutions and multiple module combinations and colors, from the simplest to the most complex composition.

Modularidad

Flexible y evolutivo, MENDI ofrece numerosas soluciones de disposición y múltiples combinaciones de módulos y colores, de la más pequeña a la mayor composición.

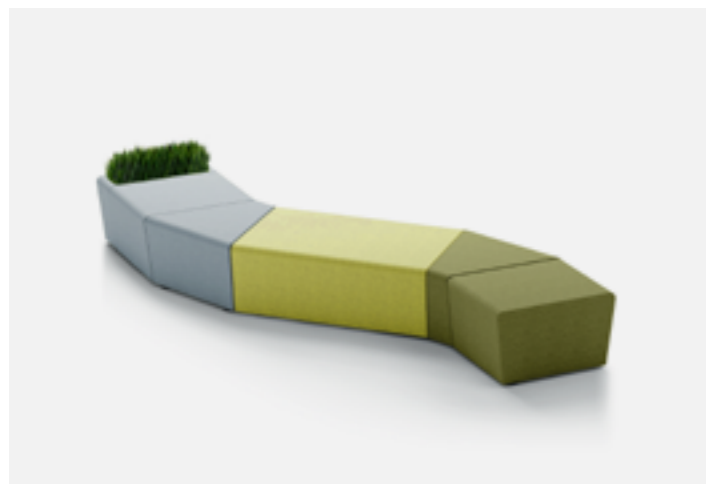
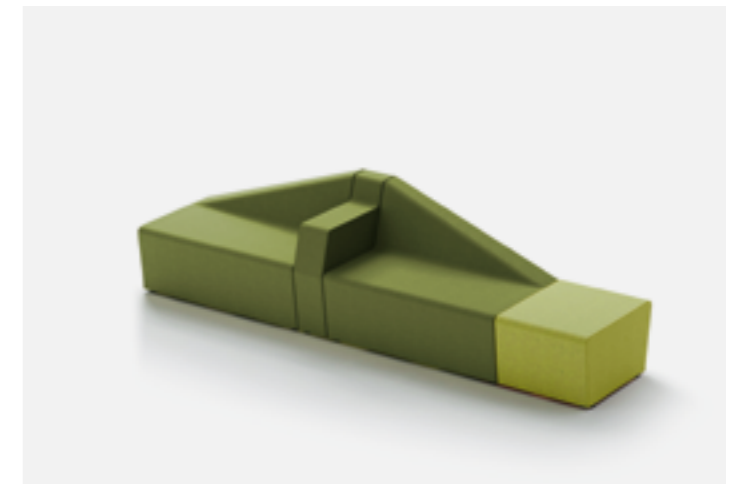
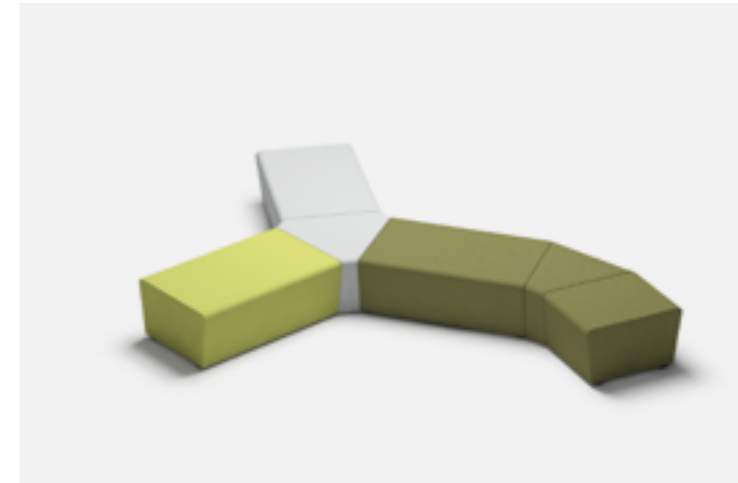

Bien-être

Aujourd'hui travailler c'est aussi :

Prendre un moment de détente pour se ressourcer et trouver l'inspiration dans un lieu plus décontracté, un cadre favorisant le bien-être personnel et où la créativité peut s'épanouir librement.

Se réunir dans un espace ouvert, accueillant, collaboratif et multifonctionnel qui permet de stimuler les esprits pour une confrontation riche et dense des idées.

Well-being

Today work is also:

To relax for a moment to recharge one's batteries and find inspiration in a more casual place, a framework for personal well-being where creativity can flourish freely.

To meet in an open, friendly, collaborative and multi-functional space that helps stimulate the spirits for a rich and dense exchange of ideas.

Bienestar

Hoy en día trabajar también es:

Cogerse un momento de descanso para recuperar fuerzas y encontrar la inspiración en un lugar relajado, un marco para el bienestar personal que favorezca la creatividad.

Reunirse en un espacio abierto, acogedor, colaborativo y multifuncional que anime a estimular los sentidos y el intercambio de ideas.



Medium

Confort

MENDI permet d'optimiser et organiser l'espace disponible de façon simple, élégante et ludique. Les différents modules sont réalisés en mousse moulée haute densité pour un confort et un soutien optimum complétés par des patins proposant deux hauteurs d'assise.

Comfort

MENDI allows to optimize and to organize the available space in a simple, elegant and ludic way. The different units are made of moulded high-density foam for comfort and optimum support. They are completed with glides that offer two seat heights.

Comodidad

MENDI permite optimizar y organizar el espacio de forma sencilla, elegante y lúdica. Los módulos, de espuma moldeada de alta densidad, ofrecen un confort óptimo. Dos tipos de tacos de apoyo permiten escoger la altura de asiento más adaptada.

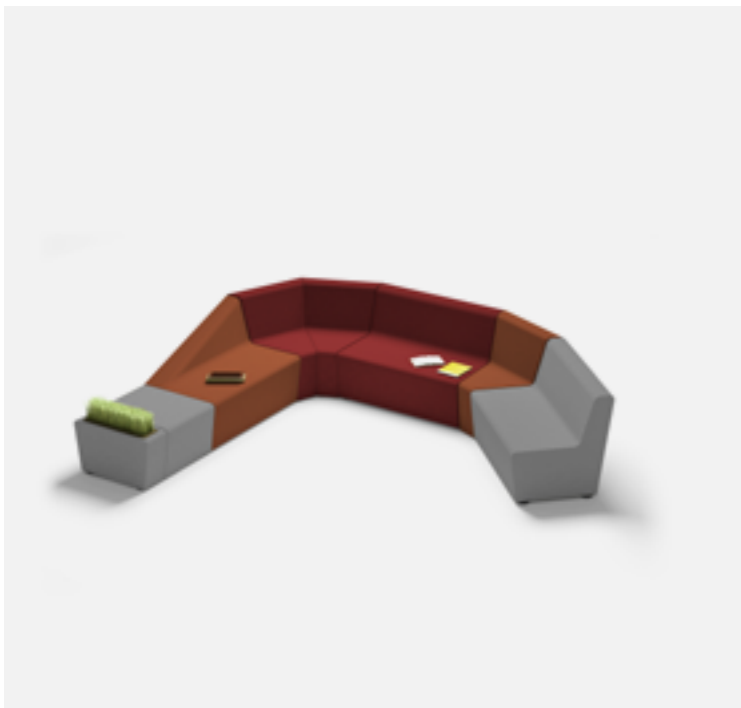

Mobilité

Toute une gamme d'accessoires donne vie au programme. Tablettes mobiles en bois, module électrique ou plantes. Tout a été pensé pour s'adapter aux besoins de mobilité tout en restant connecté.

Mobility

A full range of accessories gives life to the program: Mobile wooden tablets, electrical or plants modules. Everything has been designed to adapt to the mobility needs while remaining connected.

Movilidad

El programa dispone de una gran variedad de accesorios: repisas de madera amovibles, módulo eléctrico, módulo con decoración vegetal. Todo ha sido diseñado para adaptarse a las necesidades de movilidad manteniéndose conectado.



Large

Astucieux

Quelle que soit la configuration choisie, les modules MENDI s'assemblent entre eux simplement et sans outil à l'aide de deux platines fixées à l'avant et à l'arrière du module par vissage du patin.

Smart

Whatever the configuration, MENDI units can be assembled together without any tool; Two plates can connect the front and rear glides of the modules (glides to be screwed.)

Inteligente

Independientemente de la configuración elegida, los módulos MENDI se unen entre sí sin necesidad de herramientas, colocando dos placas de unión en los tacos de apoyo.

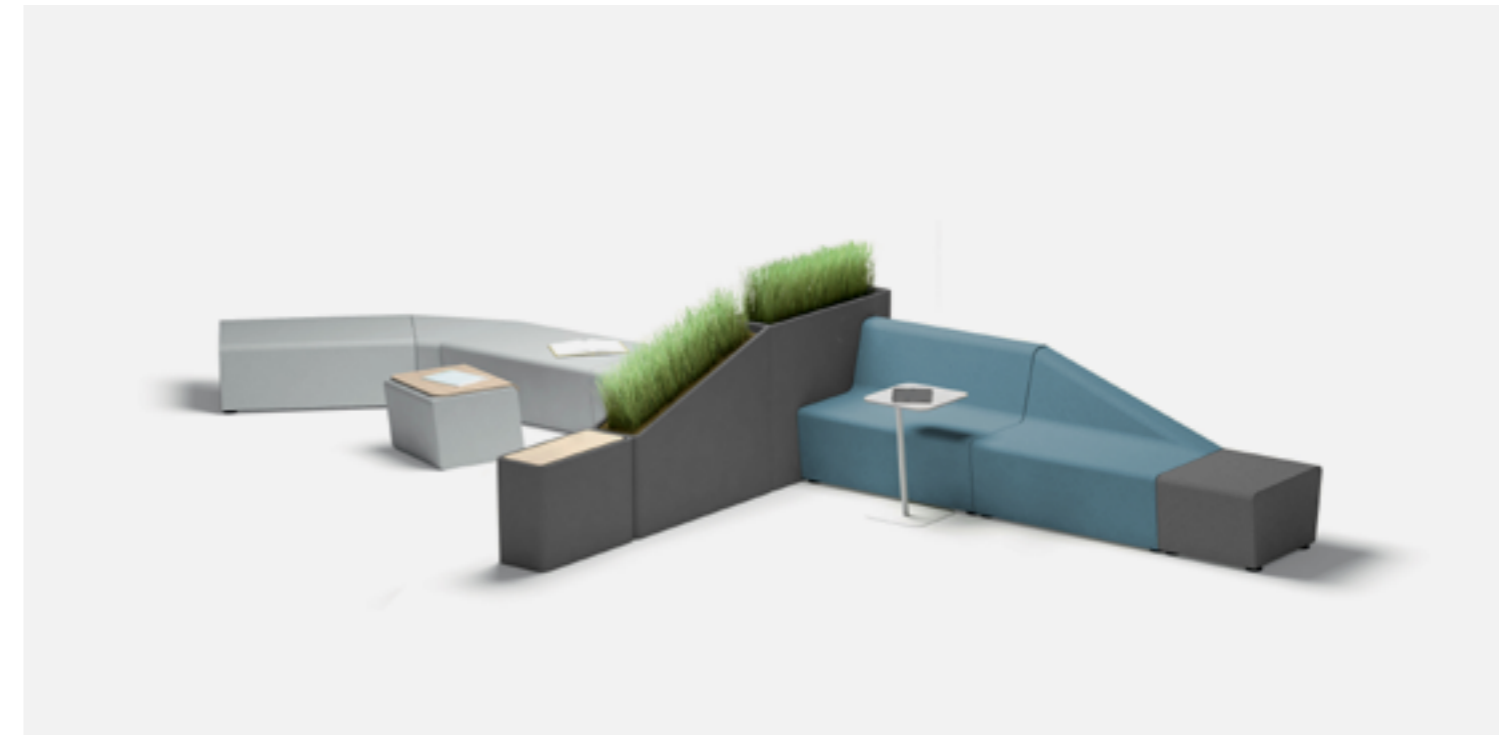
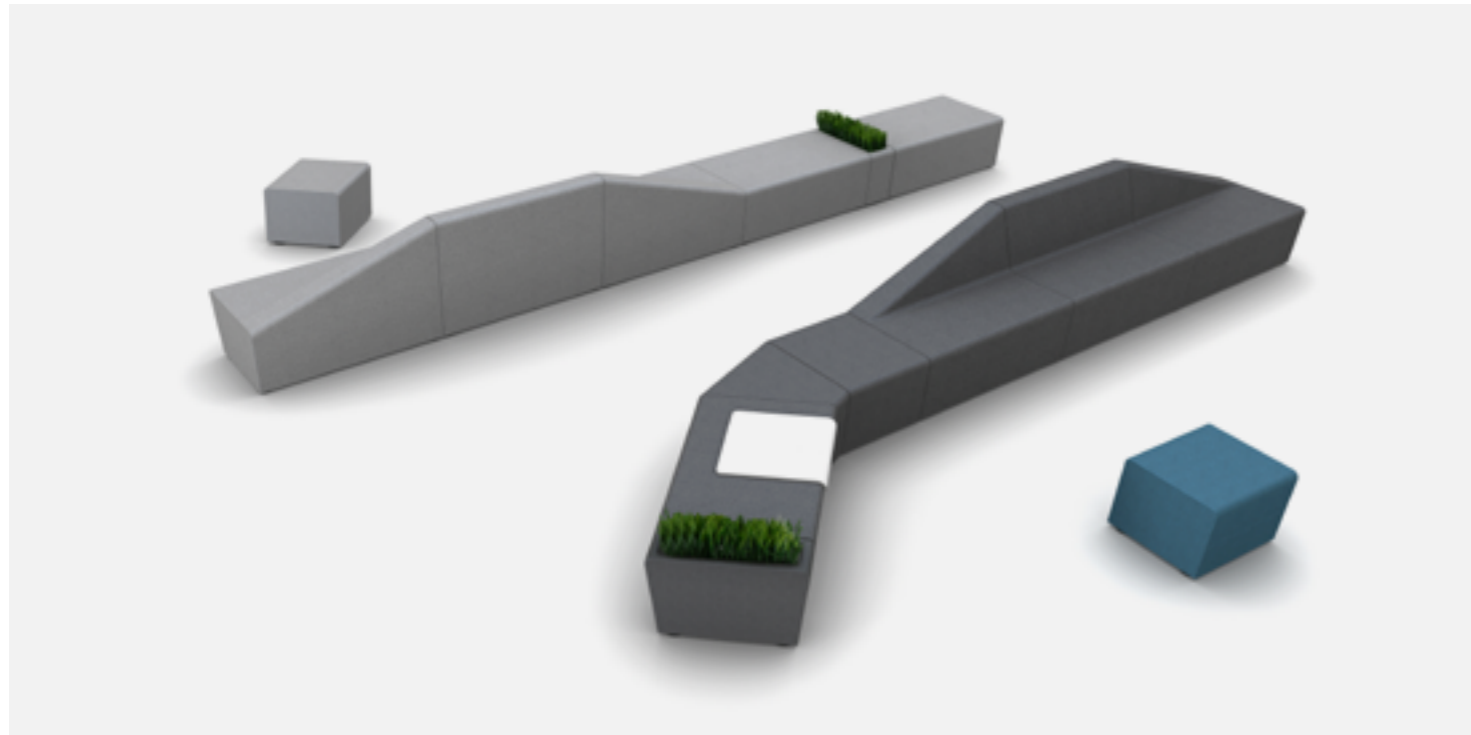
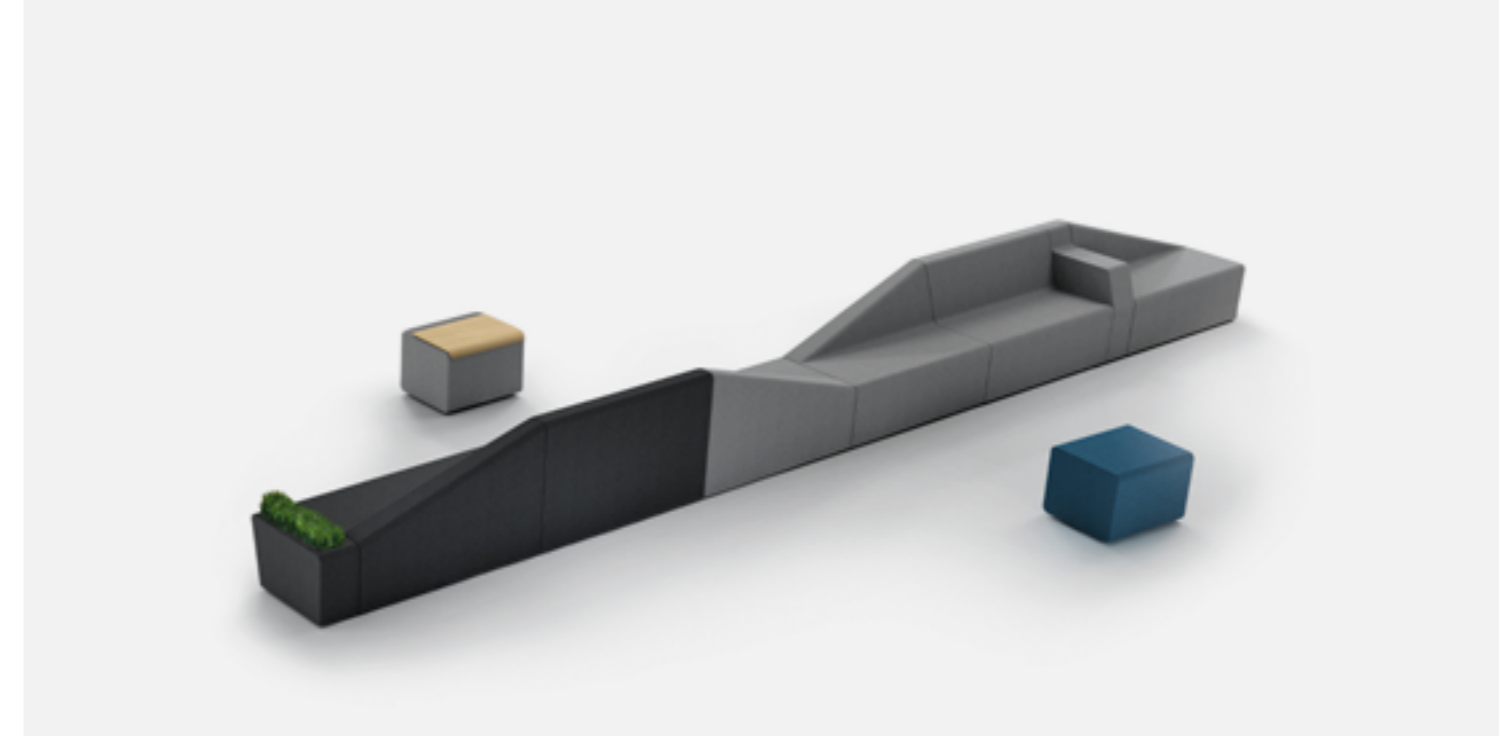
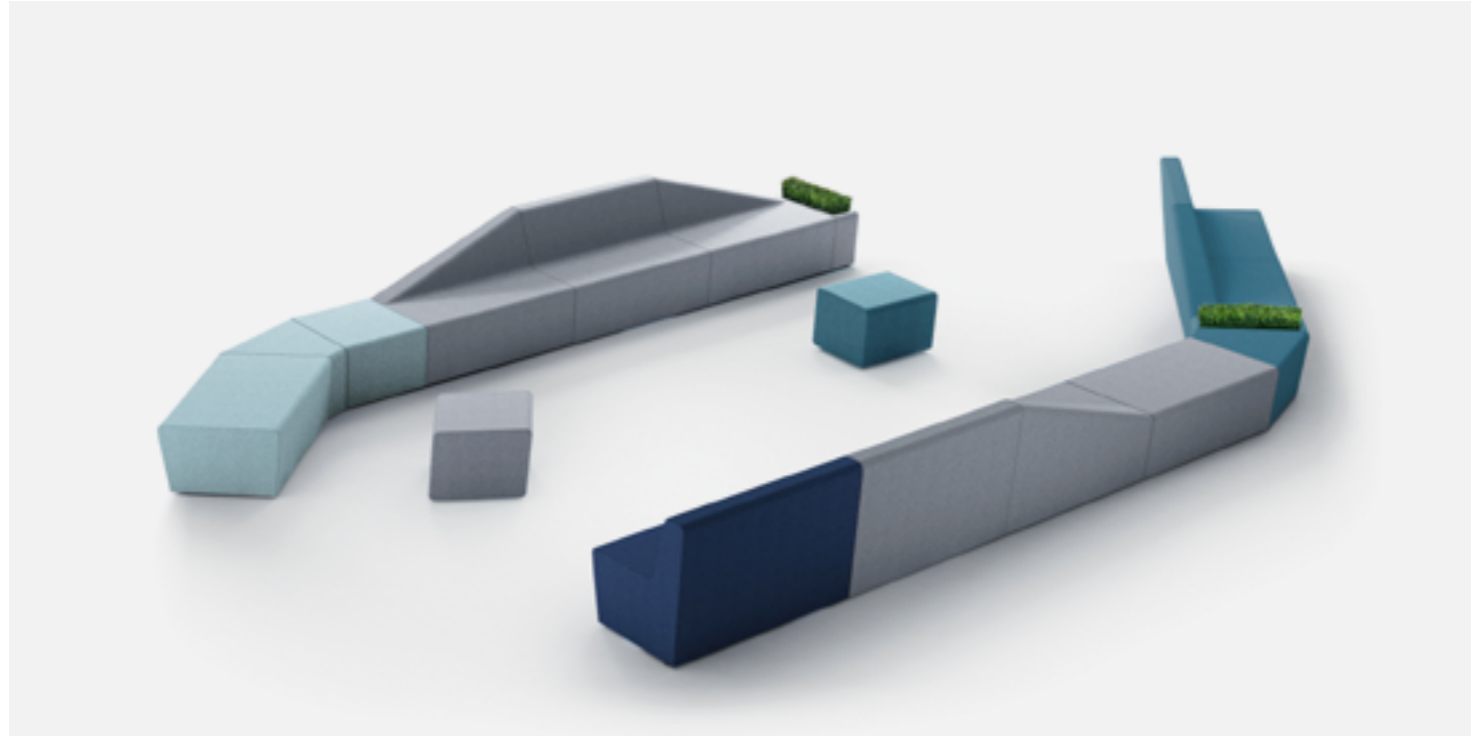

Quiksilver Europe:
Siège social. Head Offices.
Sede Social.
St Jean de Luz (64)

Convivialité

MENDI habille aussi les espaces de restauration, de pause et de détente.

Conviviality

MENDI also addresses itself to rest, pause and relaxation areas.

Acogedor

MENDI también equipa espacios de restauración y zonas de descanso.



Collaboration

L'open Space cède sa place aux espaces collaboratifs. MENDI permet de créer un îlot au cœur des espaces de travail adapté aux nouvelles formes de communication et management - briefing d'équipe et réunion express, travail d'équipes - et répond aussi au besoin de s'isoler et de se concentrer en solo ou à plusieurs, en toute décontraction ou intimité.

Co-working

Open Spaces have been replaced by collaborative spaces. MENDI creates an island in the center of work spaces that adapts to new ways of communication and management - team briefing, express meetings, training sessions - and that also responds to the need to isolate and concentrate oneself, either alone or as a group, in a relax and intimate atmosphere.

Trabajo en grupo

Los modelos de oficinas abiertas dan paso a organizaciones basadas en espacios colaborativos. MENDI crea un islote en los espacios de trabajo, adaptándose a las nuevas formas de comunicación y gestión (grupos de trabajo, reuniones exprés) y responde a la vez a la necesidad de aislarse y concentrarse en solitario o en grupo en un ambiente relajado e íntimo.



Finishes

Step & Step Mélange M1



C SVA Amande



C SMV Vert Chiné



C SMT Tilleul Chiné



C SME Eau Chiné



C SMH Horizon Chiné



C SMN Nuit Chiné



C SCC Curry



C SMP Paprika Chiné



C SM2 Paprika Chiné



C SM1 Terracotta



C SMF Fuchsia Chiné



C SM3 Violet Chiné



C SAR Argent



C SG1 Gris Moyen



C SMB Béton Chiné



C SMC Cendre Chiné

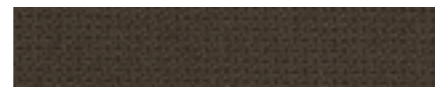

C SCH Marron

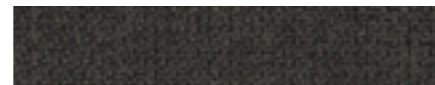

C SMG Gris Foncé Chiné

Urban M1 - Enduit PVC



C URS Absinthe



C UR0 Origan



C URT Turquoise



C URB Pétrole



C URG Géranium



C URF Fuchsia



C URP Prune



C URA Abysses



C URE Terre



C URH Chocolat



C URC Cendre



C URR Réglisse

Modules



DIW0/N0



DIX0/N0



DIY0/N0



DIG0/N0



DIP0/N0



DIQ0/N0

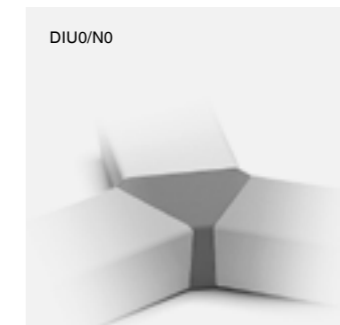

DIU0/N0



DIV0/N0



DIB0/N0

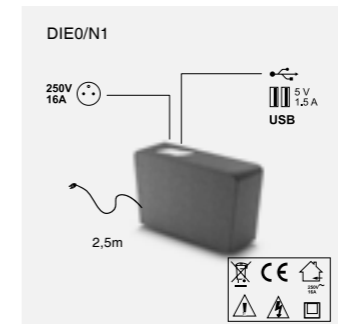

DIE0/N1

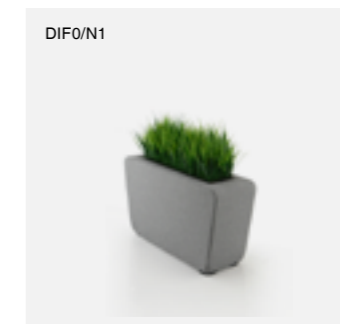

DIF0/N1



DIT0/OL



DITN/7B

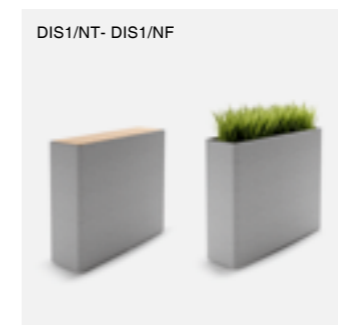

DIS1/NT- DIS1/NF



DIS2/NT- DIS2/NF



DIS3/NT- DIS3/NF

Ideas



Mendi Video:

1 min 30 tout en rythme et musique pour découvrir toutes les possibilités de ce programme modulaire, astucieux, flexible, coloré et économique. A consommer sans modération!

1 min 30 of rhythm and music to discover all the possibilities of this modular, clever, flexible, colourful and economical seating range. To consume without moderation!

1 min 30 con ritmo y música para descubrir todas las posibilidades de este programa modular, inteligente, flexible, colorido y económico. ¡Para consumir sin moderación!



YouTube

Mendi App:

Simple et ludique, l'application pour tablette et Smartphone vous permettra d'imaginer et créer vos espaces et vos configurations MENDI en quelques clics.

Simple and ludic, the app for tablet and Smartphone let you imagine and create your own spaces and MENDI configurations in just a few clicks.

Sencilla y lúdica, la aplicación para tablet y Smartphone le permitirá imaginar y crear sus propios espacios y configuraciones MENDI en pocos clics.



Special Thanks to Quiksilver Europe



Prenant en compte le design, l'ergonomie, la qualité des produits et l'exigence des utilisateurs, SOKOA, fabricant spécialiste du siège de bureau certifié ISO 9001 et ISO 14001, s'efforce de répondre avec un produit innovant, fiable et professionnel à tout besoin d'équipement. La volonté de redonner à l'homme la première place, le respect de l'environnement et l'intégration territoriale sont au centre des valeurs SOKOA, lesquelles sont déployées selon les principes du Développement Durable et de l'ISO 26000 relatifs à la Responsabilité Sociétale de notre entreprise.

As an office seating designer and manufacturer SOKOA has set itself a straightforward challenge: the supply of a wide range of products to the highest possible standards of comfort and ergonomics under a quality management system that complies to the stringent ISO 9001 and 14001, for its customers' total satisfaction. Its corporate social responsibility focused on sustainable business practices, society and the environment, as per the ISO 26000' standards, has at the same time remained at the heart of the company's activity.

SOKOA, fabricante de sillería de oficina con certificaciones ISO 9001 e ISO 14001, responde a todas las necesidades de equipamiento con un producto fiable, innovador y profesional, considerando el diseño, la ergonomía y la calidad de sus productos, así como las exigencias de los usuarios. La voluntad de dar prioridad absoluta al ser humano, el respeto al medioambiente y el desarrollo de su comunidad son tres valores fundamentales de nuestra empresa, aplicados de acuerdo con los principios del Desarrollo Sostenible y de la ISO 26000 relativa a la Responsabilidad Social de nuestra empresa.



sokoa.com

