

Ficha técnica

Plisada



Modelos

Sistema 20 mm

029001 Sistema de 20 mm

029030 Sistema de 25 mm

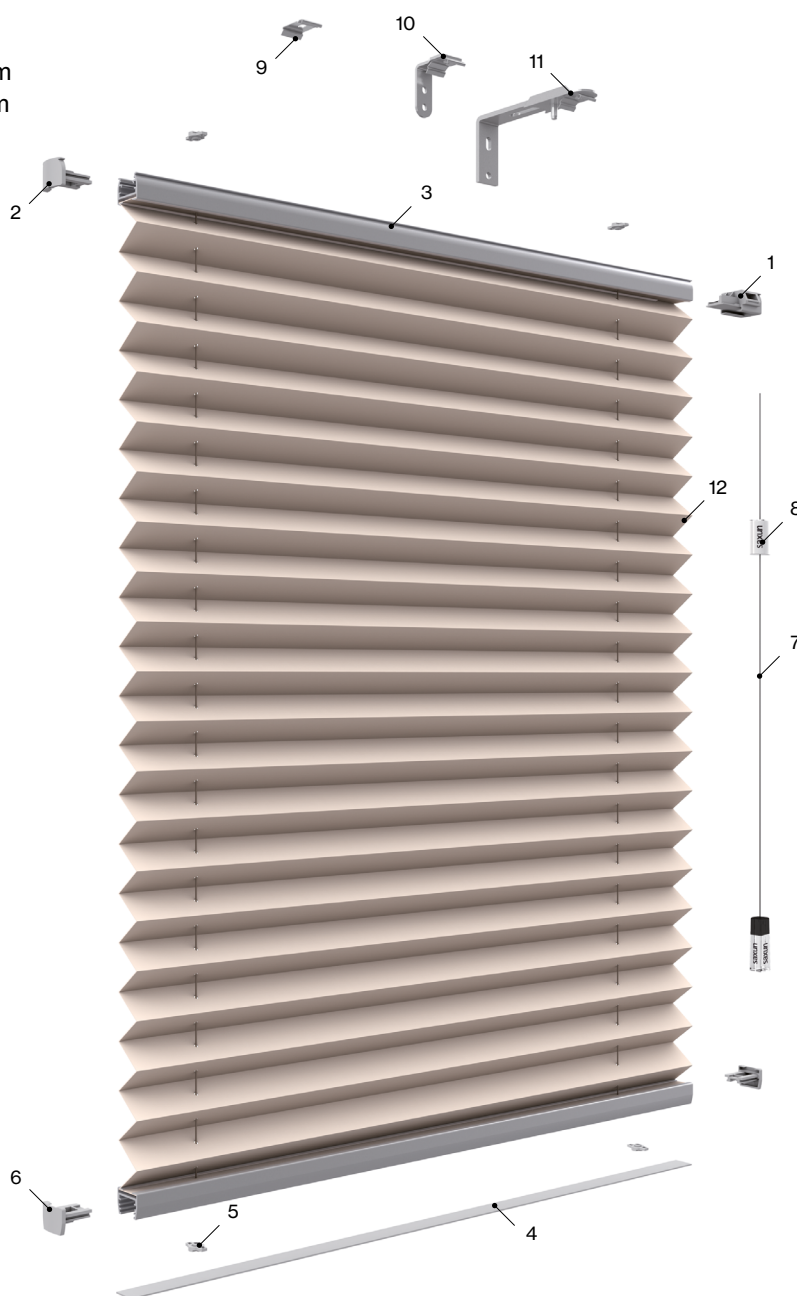

Componentes

Nº	Cód.	Descripción	Nº	Cód.	Descripción
1	029210	Mecanismo Plisada	7	029205	Cordón plisada 1:2
2	029206	Tapón perfil superior	8	029212	Igualador Plisada
3	029217	Perfil aluminio	9	029202	Soporte techo plisada sistema cordón
4	029216	Perfil PVC	10	029226	Escuadra soporte pared Plisada
5	029215	Pasa cordón	11	029227	Escuadra separación Plisada
6	029209	Tapón perfil inferior	12	029203	Cordón Plisada 0,8

Medidas de fabricación

Máximos		Mínimos	
Ancho	2,30 m	Ancho	0,30 m
Alto	3,00 m	Alto	0,30 m

Tipos de sistemas

Sistema a cadena

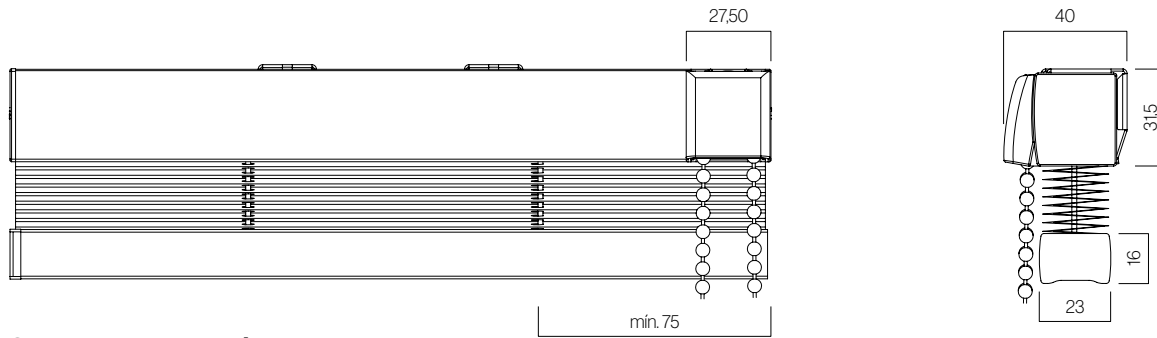

Sistema con tensión manual

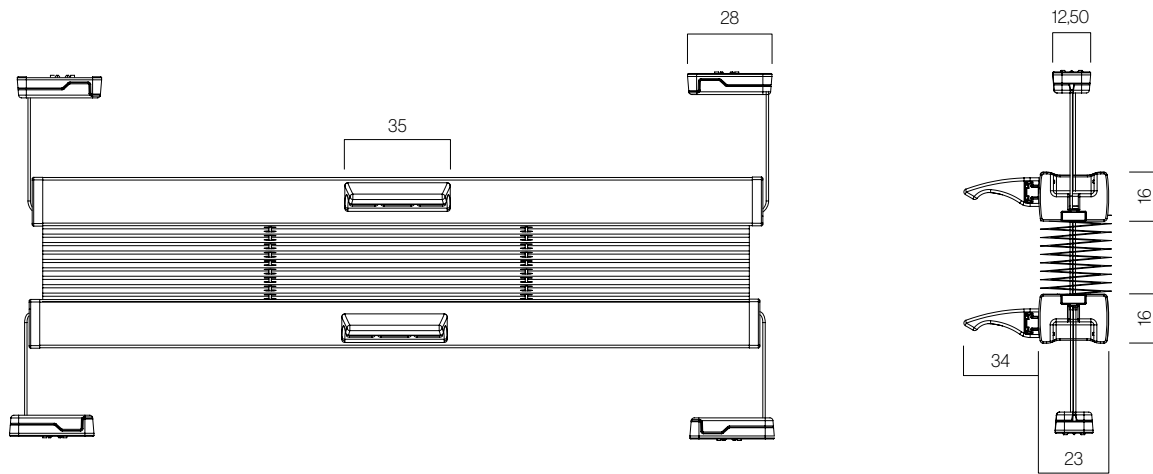

Sistema a cordón

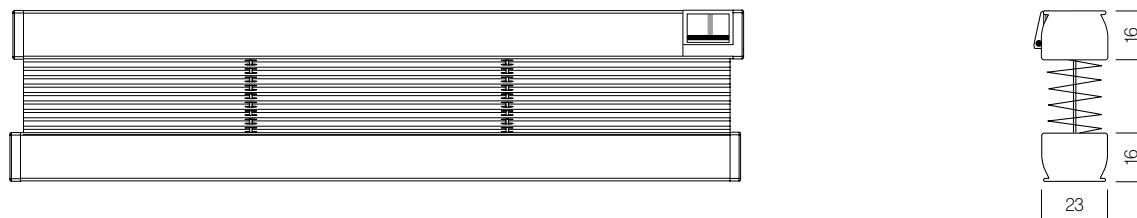

Soportes

Soportes para instalaciones a techo y a pared

Soporte techo
029202

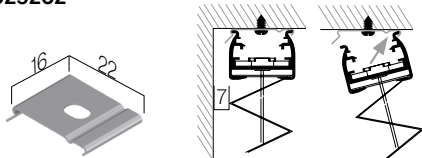

Escuadra separador
029227

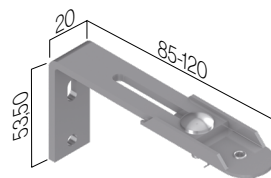

Soporte pared
029226

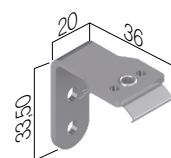

Soporte para cortina de cristal

Soporte superior

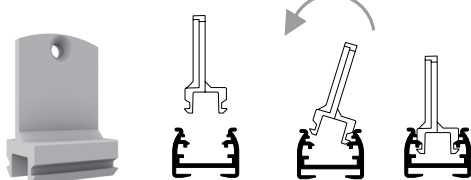

Jgo. soporte inferior

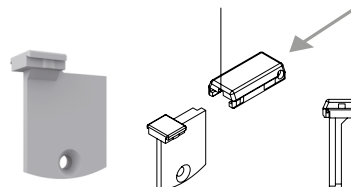

Tapa soporte



Tipos de configuración

Configuraciones

Mecanismo a cordón.
Con guías laterales
(cordón).

Mecanismo doble
cordón. Noche/día.

Accionamiento manual.
Con guías laterales
(cordón).

Accionamiento manual. Cierre
arriba/abajo
y abajo/arriba. Perfil de montaje
superior.

101

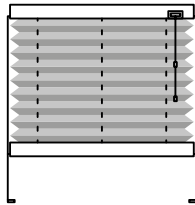

119

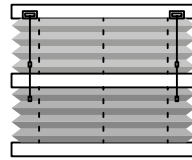

111

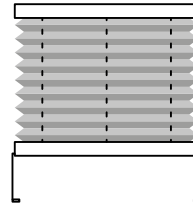

112

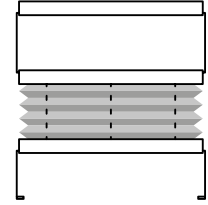

Accionamiento manual.
Noche/día.

Accionamiento manual. Con
perfil de montaje inferior.

Accionamiento manual. No-
che/día con apertura central.

Accionamiento manual. Cierre
arriba/abajo
y abajo/arriba. Perfil de montaje
superior e inferior.

113

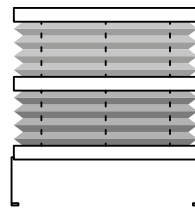

115

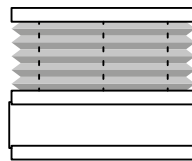

116

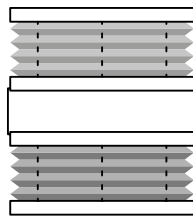

117

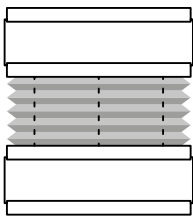

Configuraciones

Accionamiento manual. Noche/día con
perfil de montaje
inferior.

Accionamiento
manual. Apertura
central.

Accionamiento
manual. Cierre arri-
ba/abajo y abajo/
arriba.

Máximo 1,30 ancho

Máximo 0,70 ancho

Máximo 1,30 ancho

118

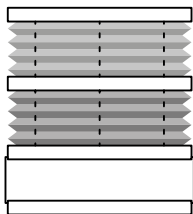

120

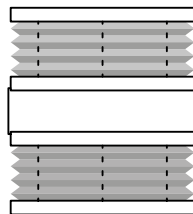

140

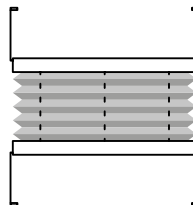

121

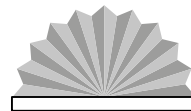

121

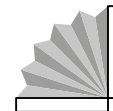

122

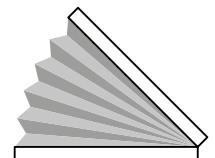

Características técnicas

Ancho máximo según el tipo de configuración

Nº configuración

Ancho máximo

111 • 112 • 113 • 114 • 115 • 116 • 117 • 118 • 119 • 120 • 140

1,20 m

Plisada Glass

029300 Sistema de 20 mm
Configuración 111 y 140

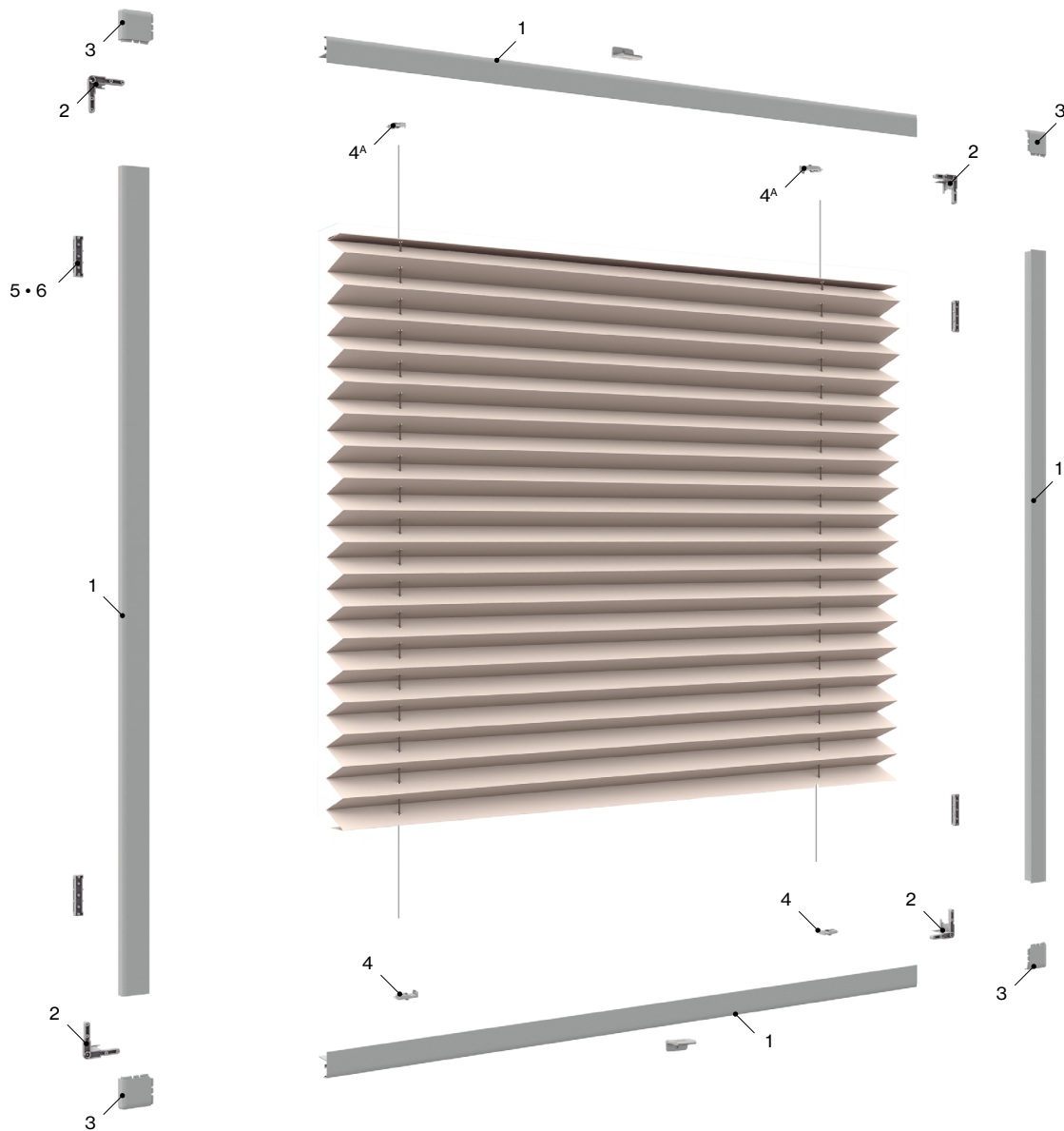
**Componentes**

Nº	Cód.	Descripción	Nº	Cód.	Descripción
1	031241	Perfil fácil ajuste 580 cm XS	4 ^A	031244	Tension shoe XS (configuración 140)
2	031242	Unión esquina XS	5	031250	Soporte XS
3	031243	Cubierta esquina white ABS XS	6	031252	Cinta de espuma acríl. 10x1,2 mm XS
4	031244	Tension shoe XS			

Medidas de fabricación

Máximos		Mínimos	
Ancho	1,20 m	Ancho	0,30 m
Alto	1,60 m	Alto	0,30 m

 Modelos

Plisada 27 Especial

029040 Sistema de 27 mm

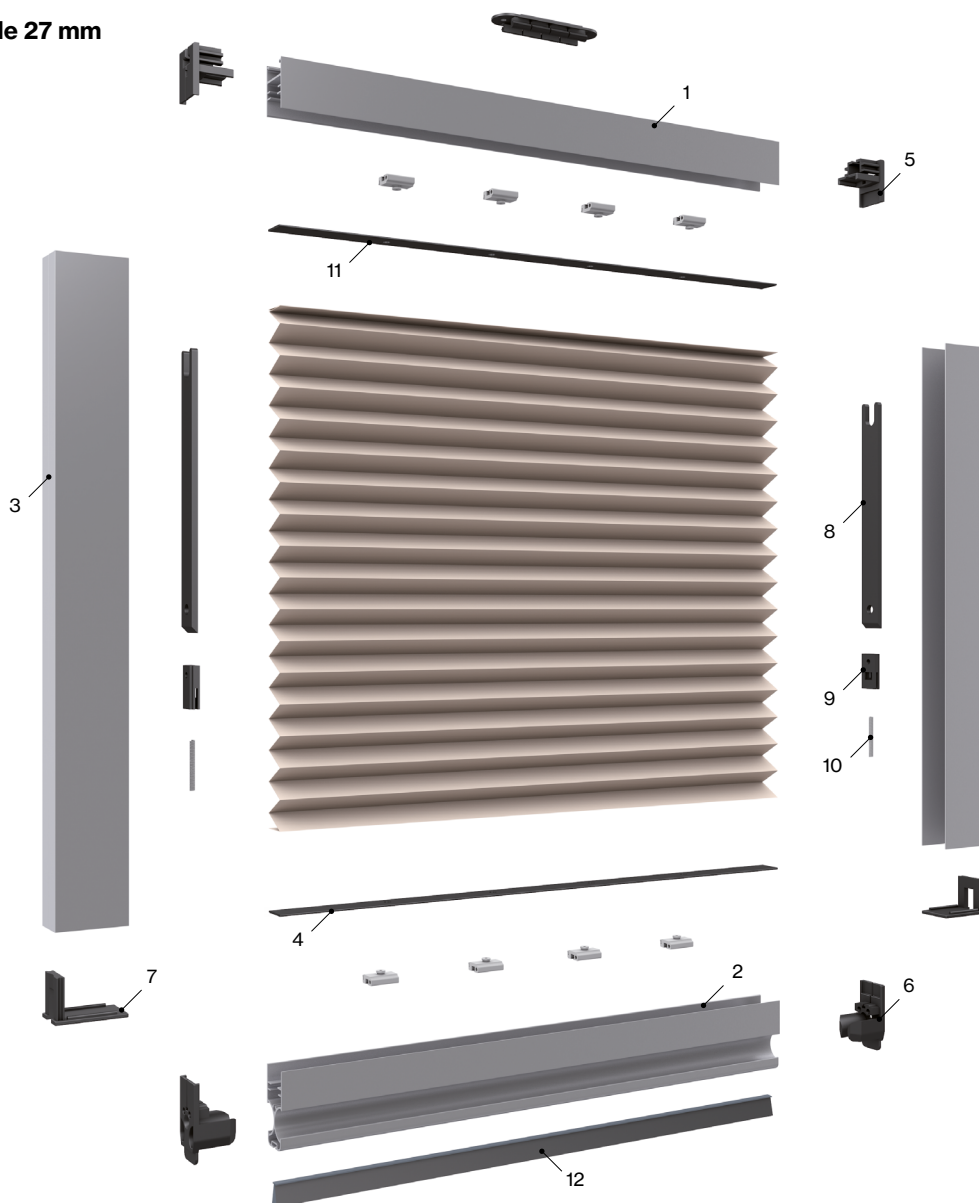

Componentes

Nº	Cód.	Descripción	Nº	Cód.	Descripción
1	042098	Perfil fijo 27	8	042126	Tope testero c/tornillo Vertical 27
2	042096	Perfil móvil 27	9	042113	Sujeción hilo con tuerca remachable 27
3	042099	Guía superior 27	10	042127	Muelle 27
4	042082	Tira PVC anclaje red H260	11	042084	Clip central 27
5	042124	Testero superior perfil fijo 27	12	042805	Felpudo 58-900
6	042125	Testero superior perfil pared	13	042023	Soporte mosquitera plisada
7	042123	Tapón inferior Vertical 27			

Medidas de fabricación

Máximos		Mínimos	
Ancho	1,60 m	Ancho	0,40 m
Alto	2,60 m	Alto	0,40 m

Características técnicas

Perfiles

Perfil móvil 27
042096

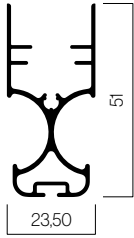

Guía superior 27
042099

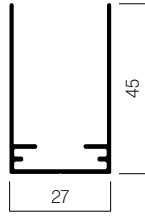

Perfil fijo 27
042098

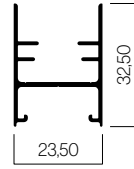

Guía Avant
031241

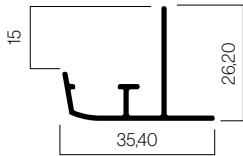

Tu mundo,
nuestro universo.

FT. PLISADA · ES · 010422

— Datasheet

Pleated blind



Models

20 mm system

029001 20 mm system

029030 25 mm system

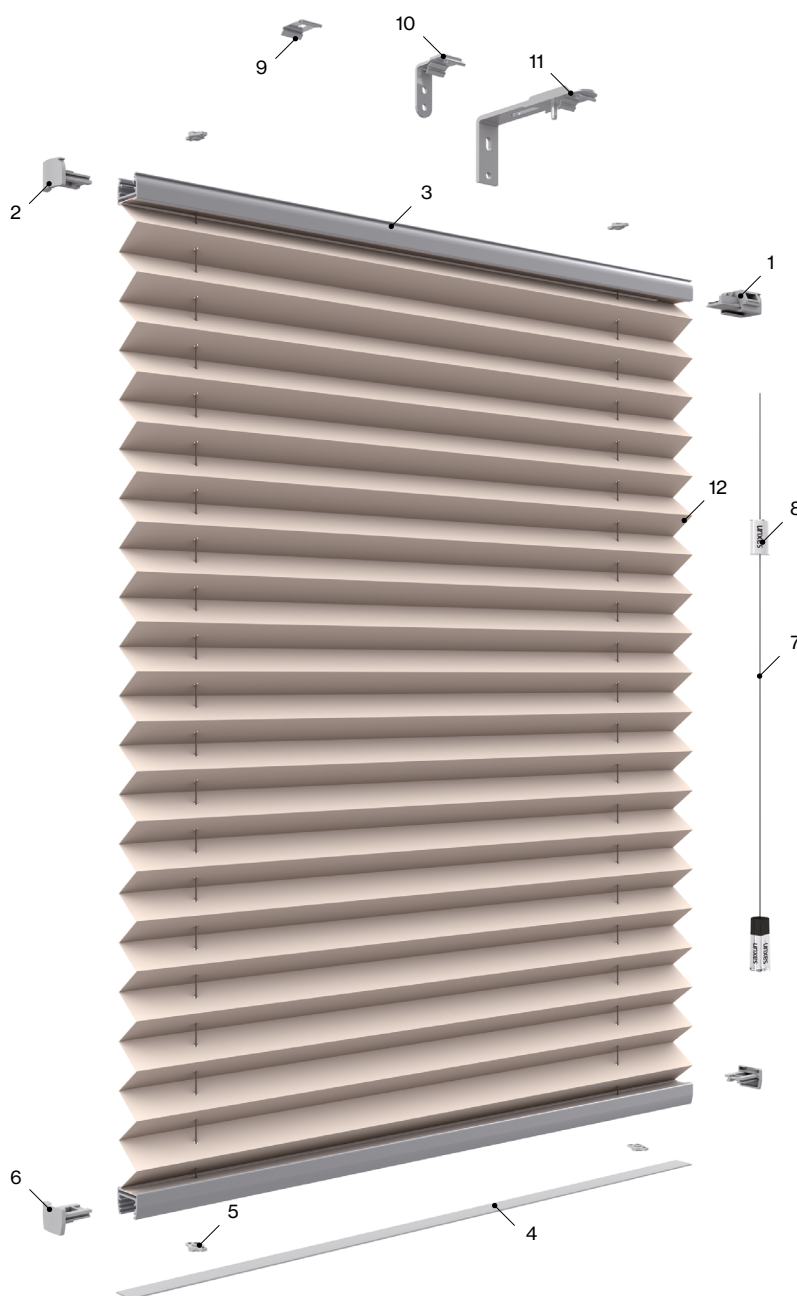

Components

Nº	Code	Description	Nº	Code	Description
1	029210	Pleated Mechanism	7	029205	Pleated cord 1:2
2	029206	Upper profile plug	8	029212	Pleated Equaliser
3	029217	Aluminium profile	9	029202	Pleated ceiling bracket cord system
4	029216	PVC profile	10	029226	Pleated square wall bracket
5	029215	Cord holder	11	029227	Pleated Separation Square
6	029209	Lower profile plug	12	029203	Pleated cord 0.8

Manufacturing measurements

Maximum		Minimum	
Width	2.30 m	Width	0.30 m
Height	3.00 m	Height	0.30 m

Types of systems

Chain system

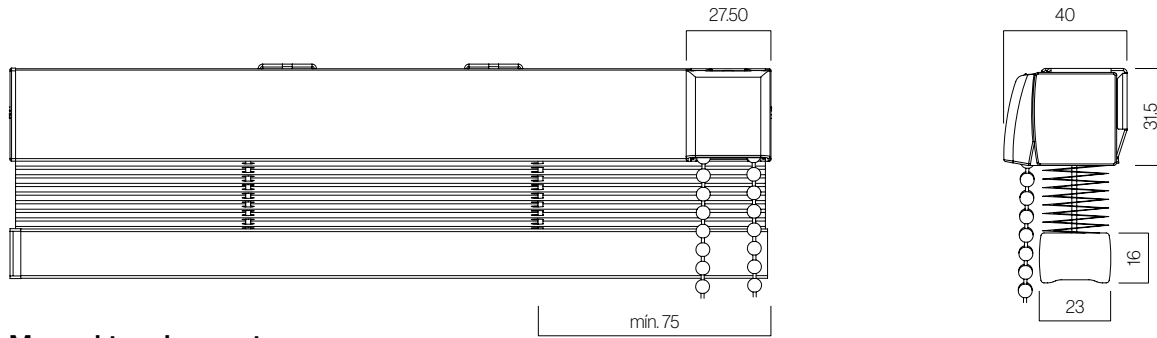

Manual tension system

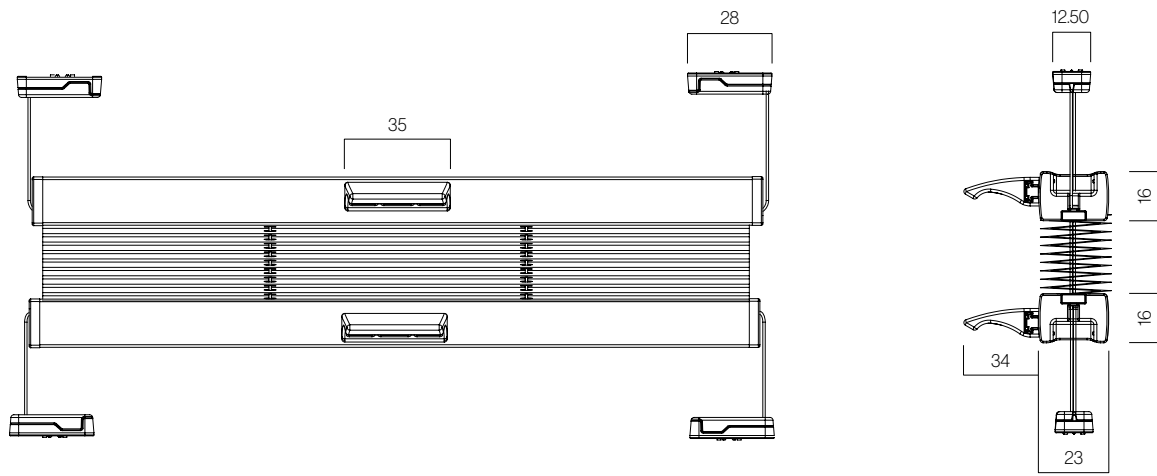

Cord system

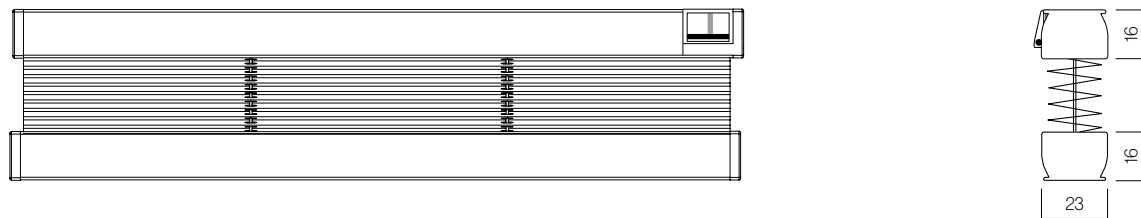

Brackets

Ceiling and wall mounting brackets

Ceiling bracket
029202

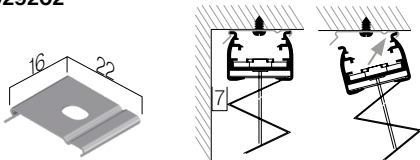

Separation angle
029227

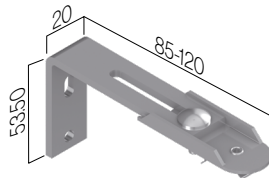

Wall bracket
029226

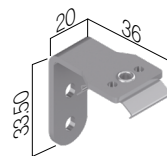

Bracket for glass curtain

Bracket Upper

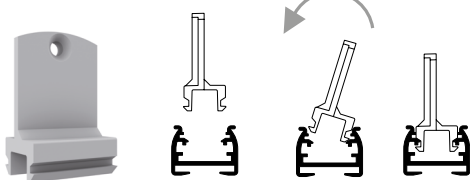

Bracket set over

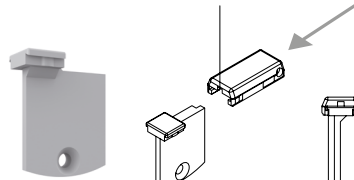

Bracket cover



Measurements in mm.

Configurations

Cord Mechanism With lateral guides (cord)	Double cord mechanism. Night/day	Manual operation With lateral guides (cord).	Manual operation. Close up/down and down/up. <i>Upper mounting profile.</i>
101	119	111	112
Manual operation Night/day.	Manual operation. With lower mounting profile.	Manual operation. Night/day with central opening.	Manual operation Close up/down and top/bottom <i>Upper and lower mounting profile.</i>
113	115	116	117

Configurations

Manual operation Night/day with lower mounting profile.	Manual operation Central opening.	Manual operation Close up/down and down/up.	Maximum width 1.30	Maximum width 0.70	Maximum width 1.30
118	120	140	121	121	122

Technical characteristics

Maximum width according to configuration type

Nº configuration	Maximum width
111 • 112 • 113 • 114 • 115 • 116 • 117 • 118 • 119 • 120 • 140	1.20 m

Glass pleated blind

029300 20 mm system
Configuration 111 and 140

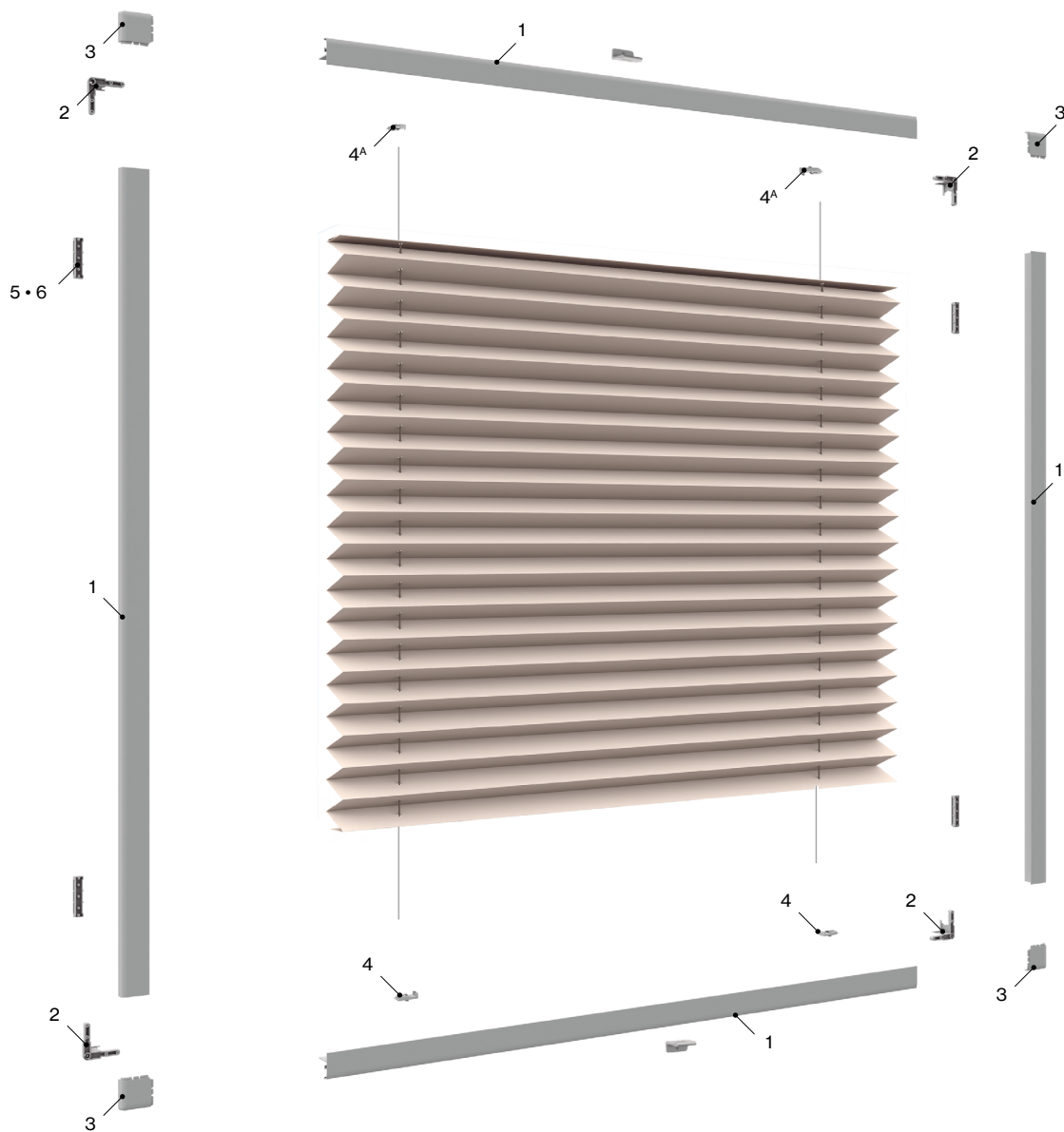

Components

Nº	Code	Description	Nº	Code	Description
1	031241	Easy adjustment profile 580 cm XS	4 ^A	031244	Tension shoe XS (140 configuration)
2	031242	Union corner XS	5	031250	Support XS
3	031243	Corner cover white ABS XS	6	031252	Cinta de espuma acril. 10x1.2 mm XS
4	031244	Tension shoe XS			

Manufacturing measurements

Maximum		Minimum	
Width	1.20 m	Width	0.30 m
Height	1.60 m	Height	0.30 m

 Models

Reversible pleated blind 27

029040 27 mm system

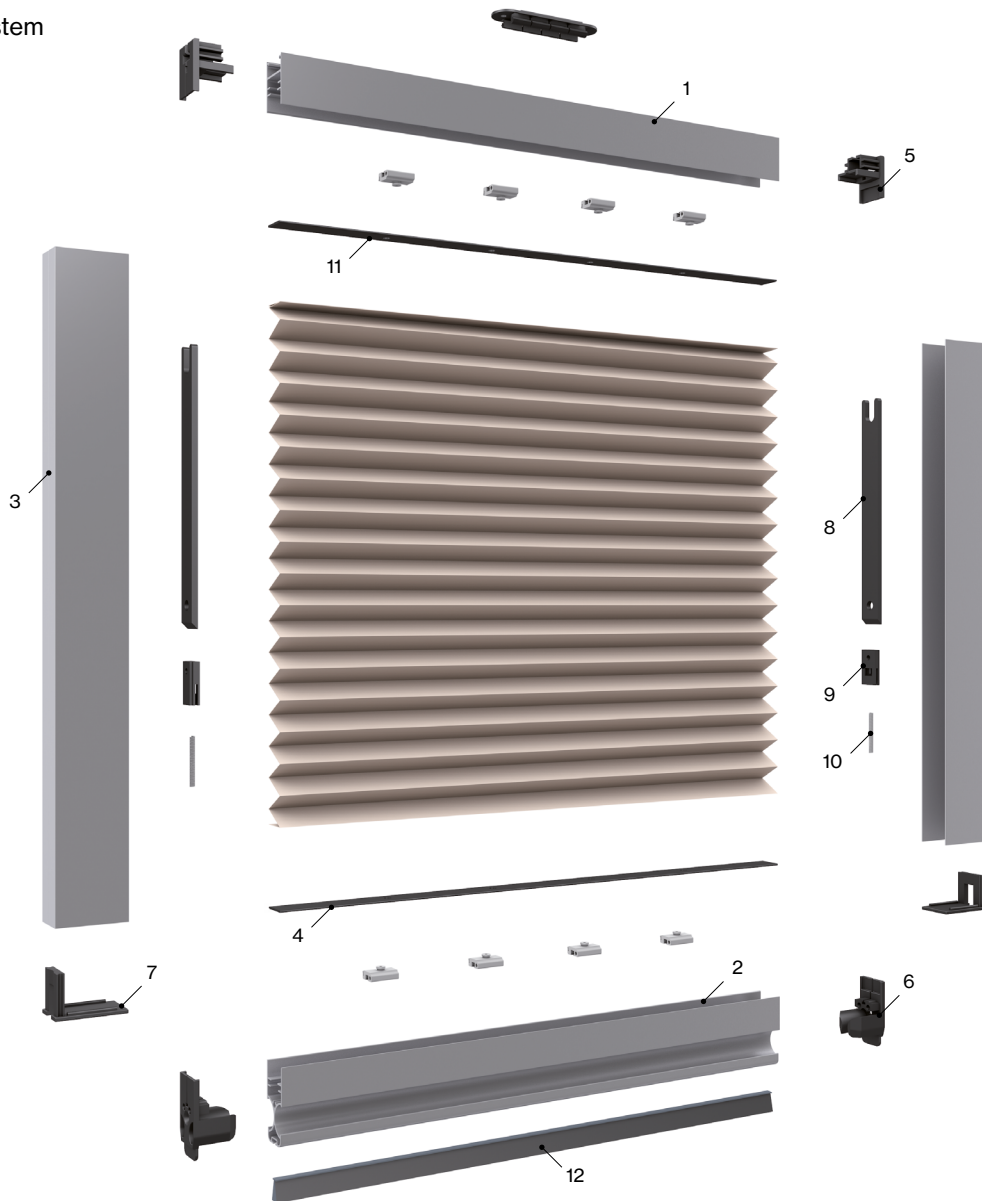

Components

Nº	Code	Description	Nº	Code	Description
1	042098	Fixed profile 27	8	042126	Vertical 27 End plate stopper with screw
2	042096	Mobile profile 27	9	042113	Thread clamp with blind rivet nut 27
3	042099	Upper guide 27	10	042127	Spring 27
4	042082	PVC strip H260 net anchorage	11	042084	Central clip 27
5	042124	Upper end plate fixed profile 27	12	042805	Brush 58-900
6	042125	Upper end plate wall profile	13	042023	Pleated mosquito screen bracket
7	042123	Vertical 27 lower cap			

Manufacturing measurements

Maximum		Minimum	
Width	1.60 m	Width	0.40 m
Height	2.60 m	Height	0.40 m

Technical characteristics

Profiles

Mobile profile 27
042096

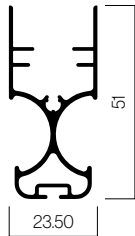

Upper guide 27
042099

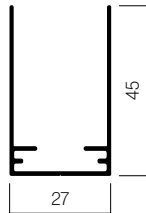

Fixed profile 27
042098

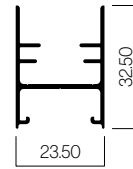

Avant guide
031241

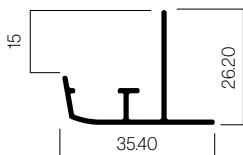

Your world,
our universe.

F.T. PLISADA · EN · 010422

Ficha técnica

Plissé



Modèles

Système 20 mm

029001 Système de 20 mm

029030 Système de 25 mm

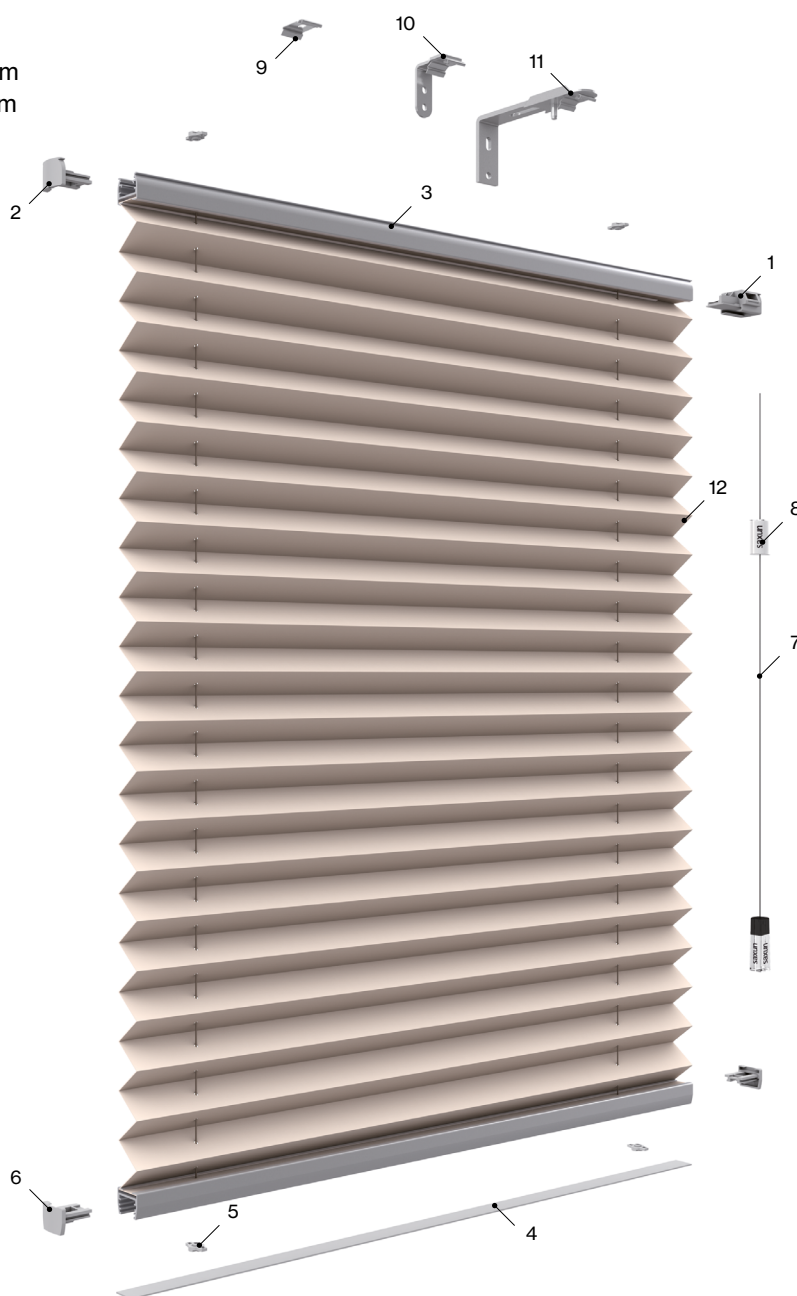

Éléments

N°	Réf.	Description	N°	Réf.	Description
1	029210	Mécanisme Plissé	7	029205	Cordon Plissé 1:2
2	029206	Bouchon profil supérieur	8	029212	Égalisateur Plissé
3	029217	Profil aluminium	9	029202	Support plafond système cordon Plissé
4	029216	Profil PVC	10	029226	Équerre support mur Plissé
5	029215	Coulissant pour cordon	11	029227	Équerre Plissé
6	029209	Bouchon profil inférieur	12	029203	Cordon Plissé 0,8

Mesures de fabrication

Maximums		Minimums	
Largeur	2,30 m	Largeur	0,30 m
Hauteur	3,00 m	Hauteur	0,30 m

Types de systèmes

Système à chaîne

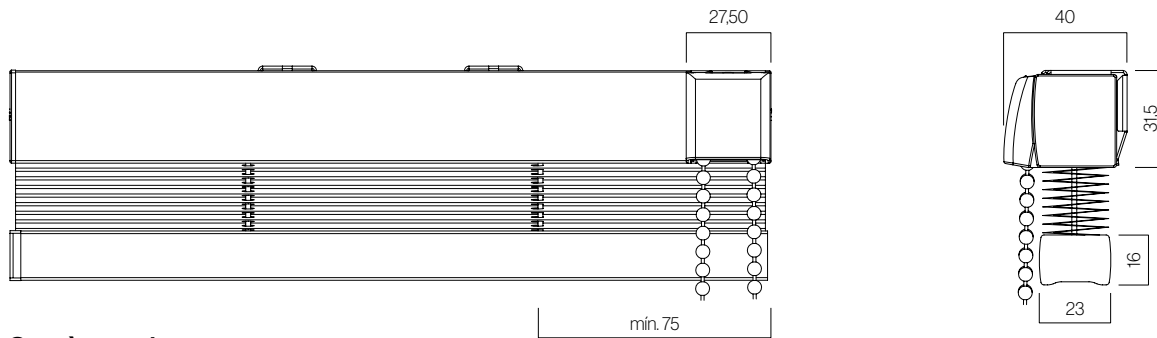

Système à languette

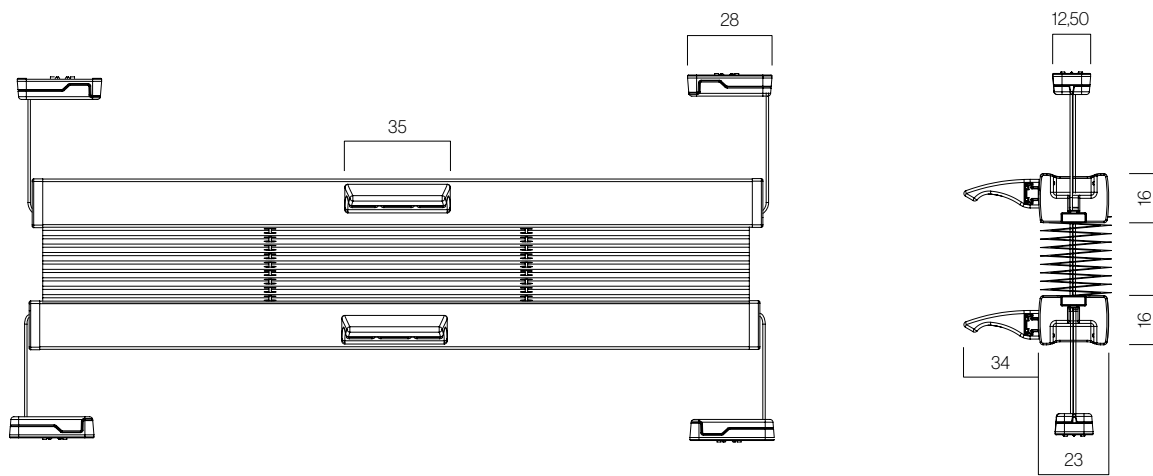

Système à cordon



Supports

Supports pour installations au plafond et au mur

Support plafond
029202

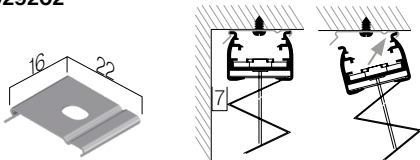

Séparateur équerres
029227

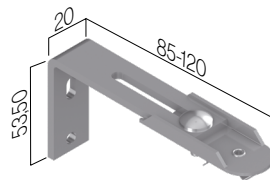

Support mur
029226

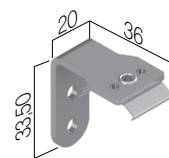

Support de verre rideaux

Support supérieur

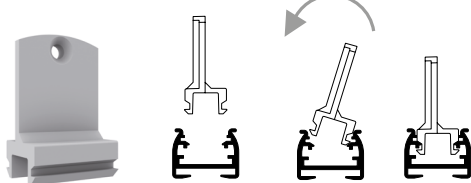

Jeux support inférieur

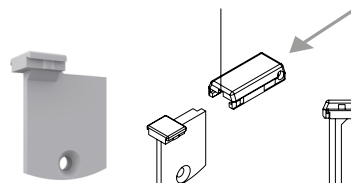

Embout support



Dimensions en mm.

Types de configuration

Configuration

Système par cordon Avec guides latéraux (cordon).

Système double cordon Jour/nuit.

Système à languette Avec guides latéraux (cordon).

Système à languette Fermeture du haut vers le bas et bas vers le haut. Profil de montage supérieur.

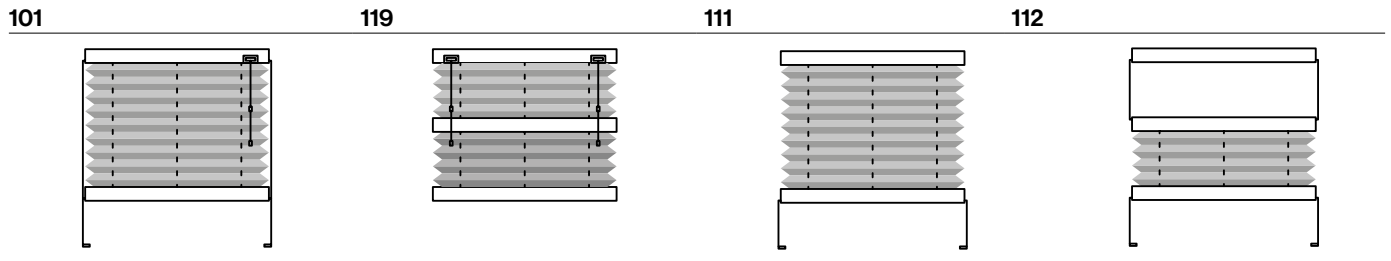

Système à languette Jour/nuit.

Système à languette Avec profil de montage inférieur.

Système à languette Jour/nuit avec ouverture centrale.

Système à languette Fermeture du haut vers le bas et bas vers le haut. Profil de montage supérieur et inférieur.

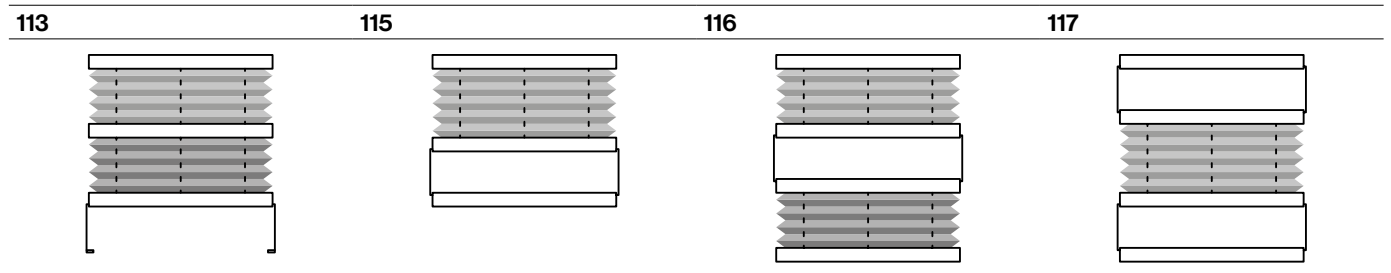

Configuration

Système à languette. Jour/nuit avec profil de montage inférieur.

Système à languette Rideau divisé.

Système à languette. Fermeture du haut vers le bas et bas vers le haut sans profils de montage.

Largeur maximum 1,30

Largeur maximum 0,70

Largeur maximum 1,30

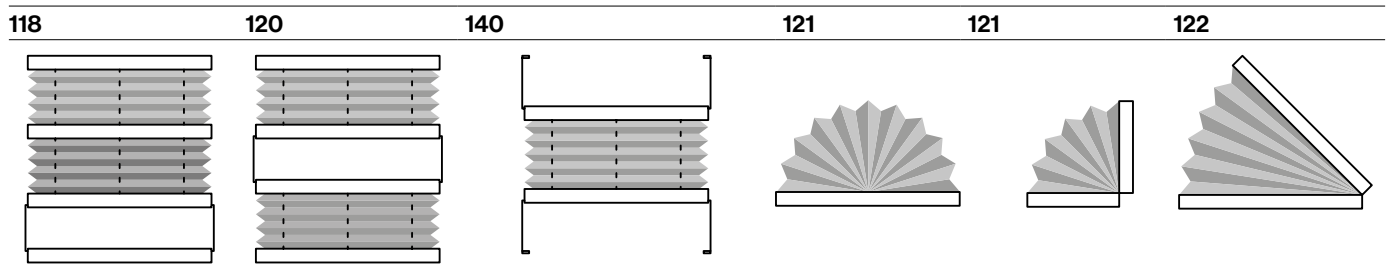

Caractéristiques techniques

Largeurs maximales selon le type de configuration

N° configuration	Largeur maximum
111 • 112 • 113 • 114 • 115 • 116 • 117 • 118 • 119 • 120 • 140	1,20 m

Plissé Glass

029300 Système de 20 mm
Configuración 111 y 140

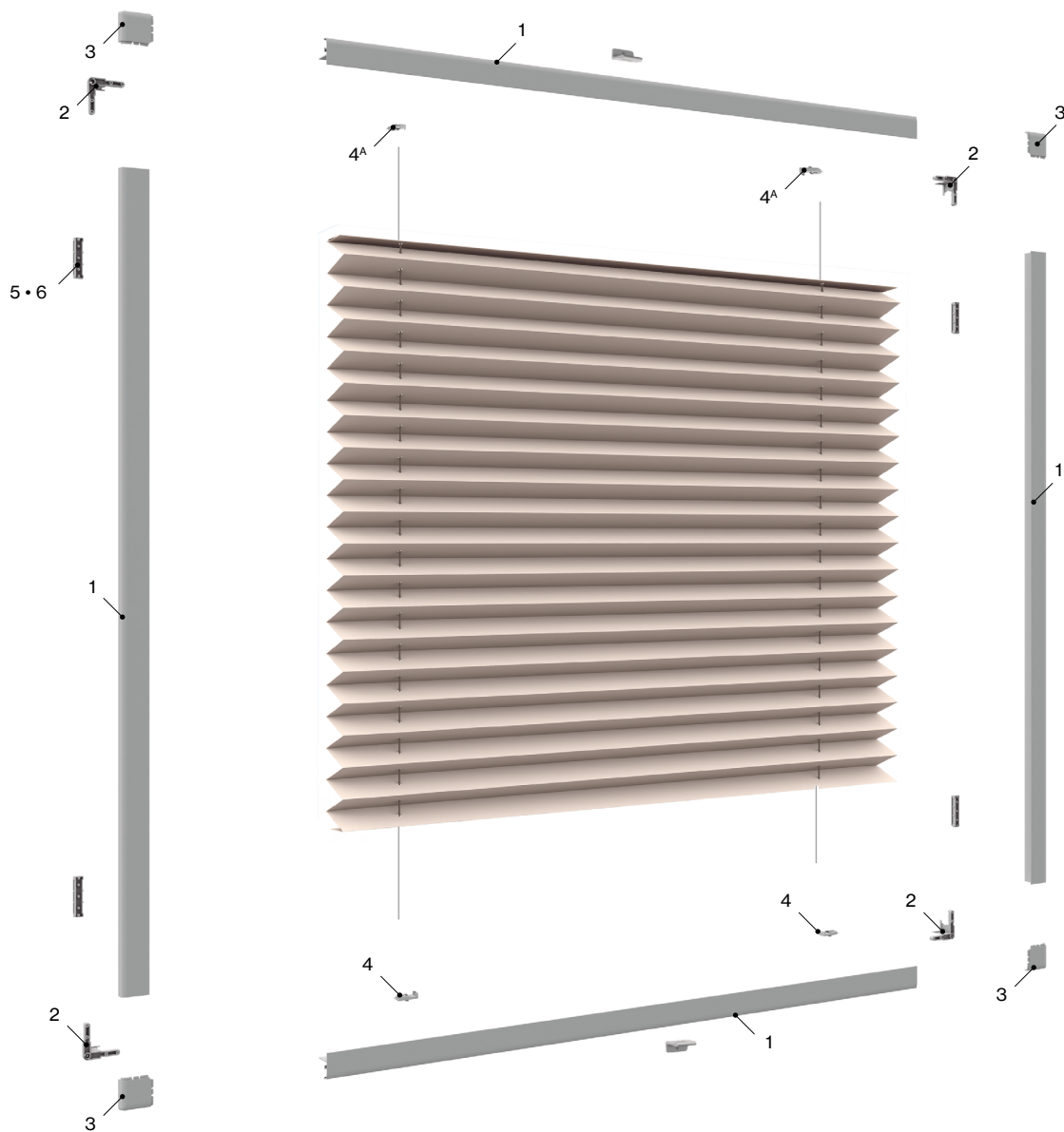

Éléments

N°	Réf.	Description	N°	Réf.	Description
1	031241	Profil facile à ajuster 580 cm XS	4 ^A	031244	Tension Shoe XS (configuration 140)
2	031242	Union coin XS	5	031250	Support XS
3	031243	Couverture d'angle blanc ABS XS	6	031252	Ruban de mousse acrylique. 10x1,2 mm XS
4	031244	Tension Shoe XS			

Mesures de fabrication

Maximums		Minimums	
Largeur	1,20 m	Largeur	0,30 m
Hauteur	1,60 m	Hauteur	0,30 m

 Modèles

Plissé 27 Spécial

029040 Système de 27 mm

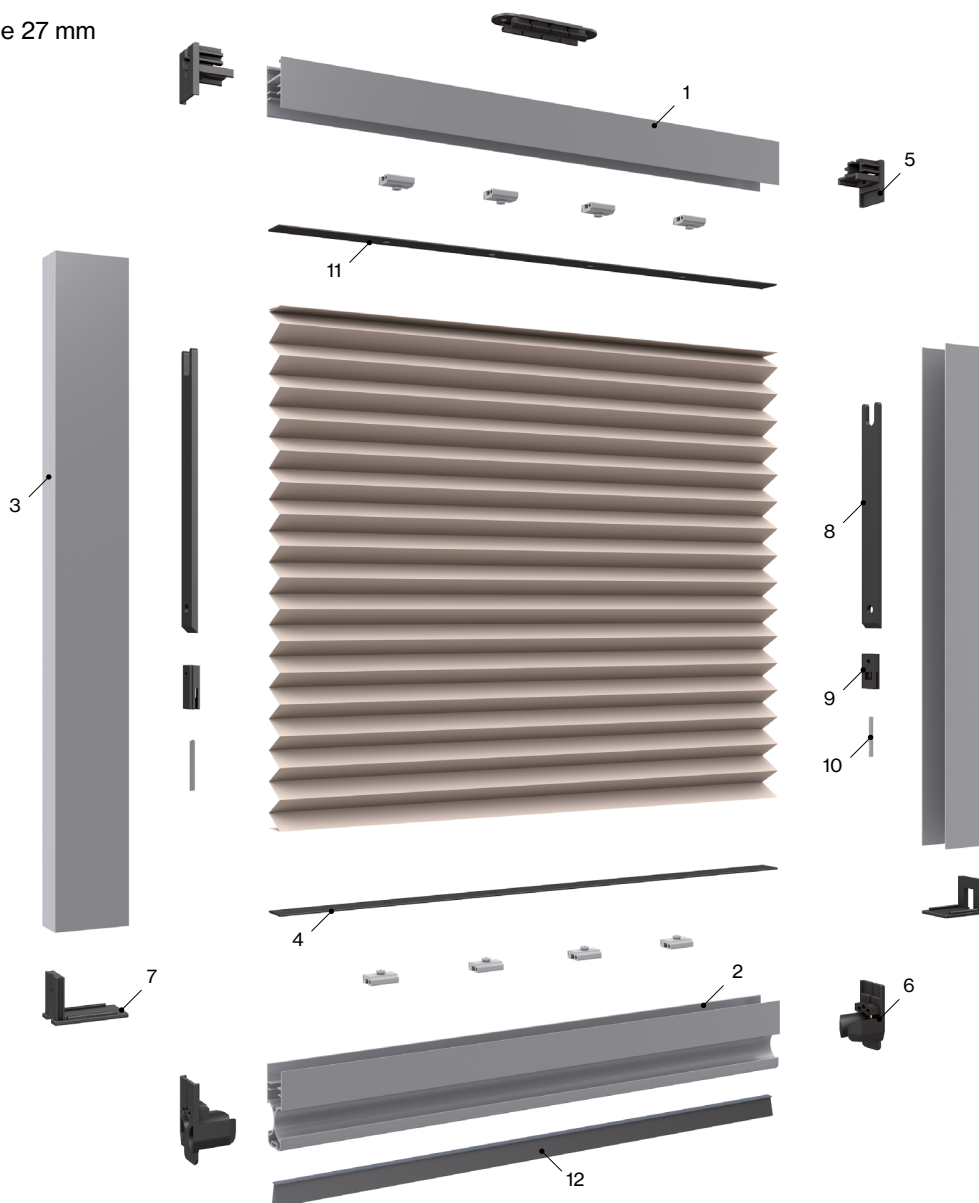

Éléments

N°	Réf.	Description	N°	Réf.	Description
1	042098	Profil fixe 27	8	042126	Arrêter embout avec vis Vertical 27
2	042096	Profil mobile 27	9	042113	Filetage de fixation avec écrou riveté 27
3	042099	Coulisse supérieur 27	10	042127	Ressort 27
4	042082	Bande PVC réseau d'ancrage H260	11	042084	Clip central 27
5	042124	Embout supérieure profil fixe 27	12	042805	Joint brosse 58-900
6	042125	Embout supérieure profil mur	13	042023	Support moustiquaire Plissé
7	042123	Embout inférieure Vertical 27			

Mesures de fabrication

Maximums		Minimums	
Largeur	1,60 m	Largeur	0,40 m
Hauteur	2,60 m	Hauteur	0,40 m

Caractéristiques techniques

Profils

Profil mobile 27
042096

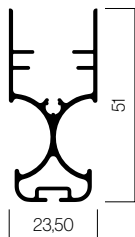

Coulisse supérieure 27
042099

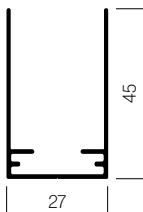

Profil fixe 27
042098

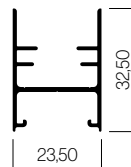

Guide Avant
031241

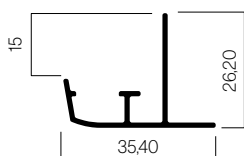

Votre monde,
notre univers.

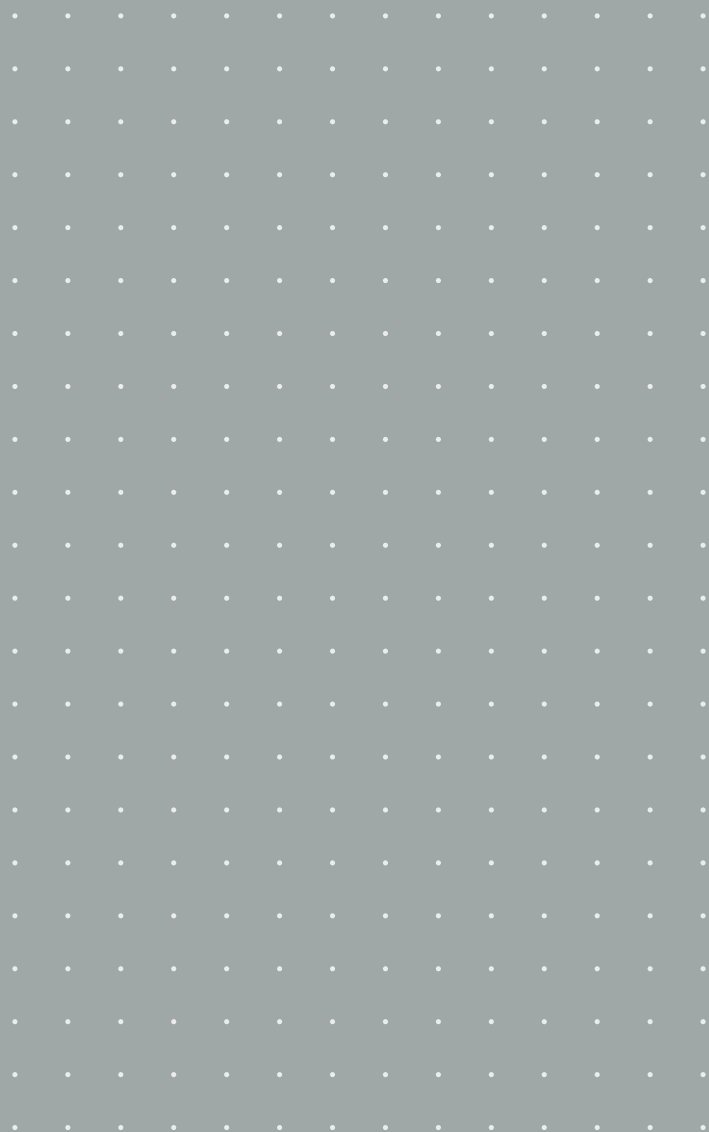

— Scheda tecniche

Plissettata



Modelli

Sistema 20 mm

029001 Sistema de 20 mm

029030 Sistema de 25 mm

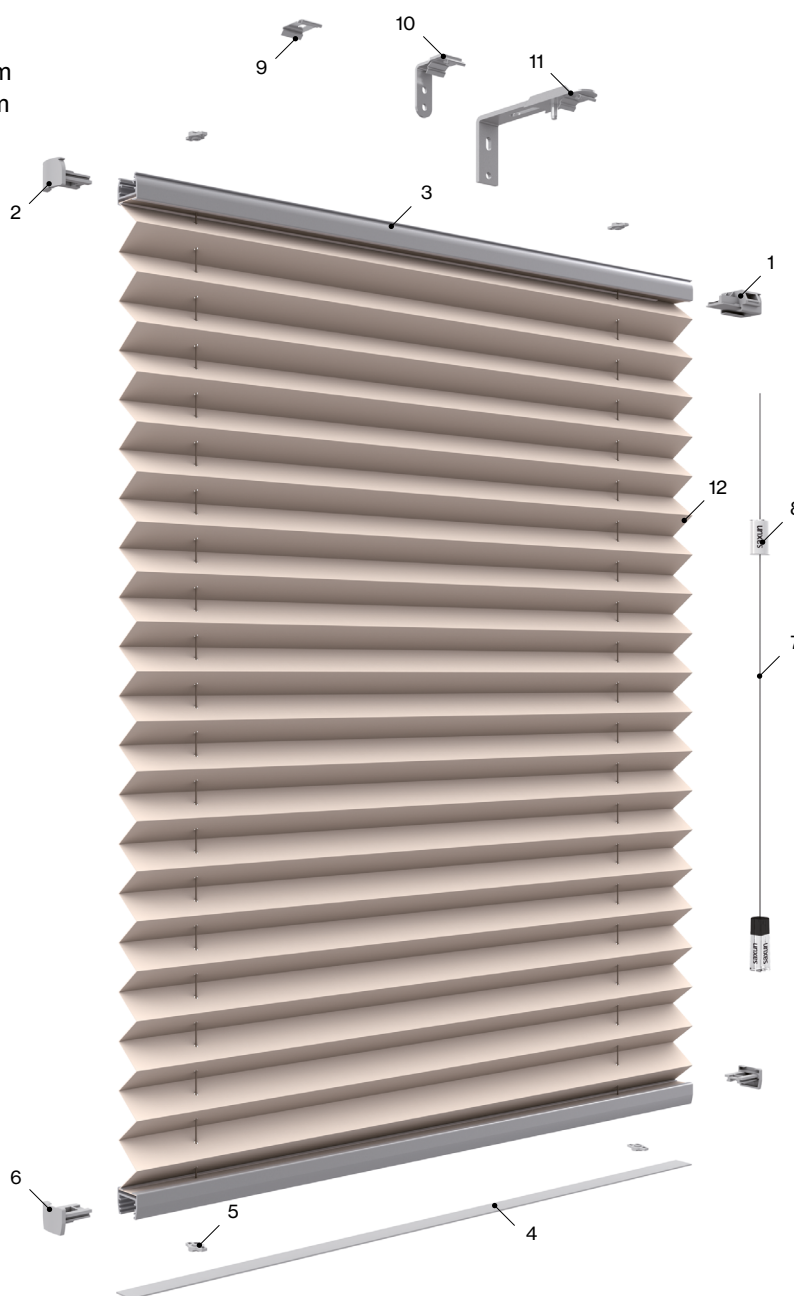

Componenti

N°	Codice	Descrizione	N°	Codice	Descrizione
1	029210	Meccanismo Plissettata	7	029205	Corda plissettata 1:2
2	029206	Tappo profilo superiore	8	029212	Giunta Plissettata
3	029217	Profilo in alluminio	9	029202	Supporto per soffitto plissettata sistema corda
4	029216	Profilo in PVC	10	029226	Staffa supporto parete Plissettata
5	029215	Passacorda	11	029227	Staffa di separazione Plissettata
6	029209	Tappo profilo inferiore	12	029203	Corda plissettata 0,8

Misure di produzione

Massimo		Minimo	
Larghezza	2,30 m	Larghezza	0,30 m
Altezza	3,00 m	Altezza	0,30 m

Tipologie di sistemi

Sistema a catena

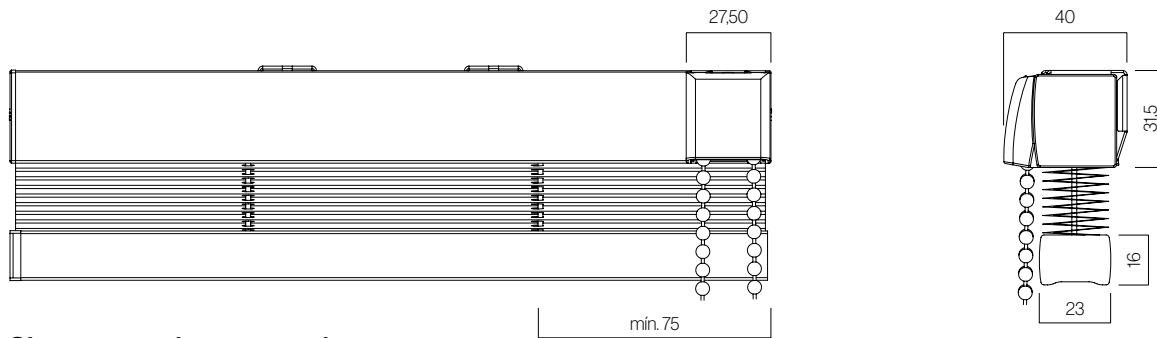

Sistema tensione manuale

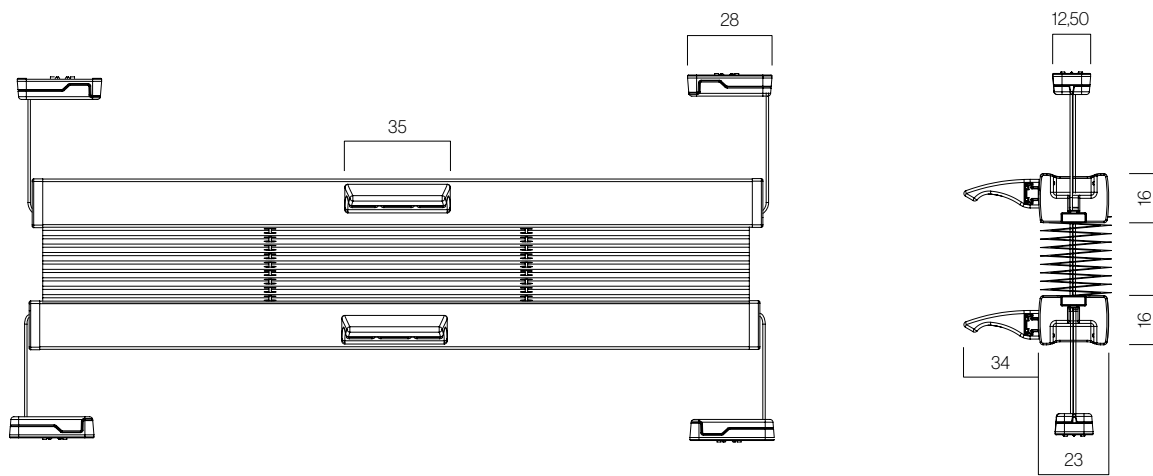

Sistema a corda

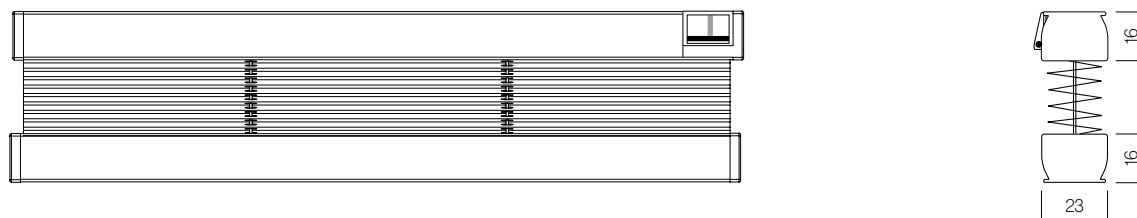

Supporti

Supporti per installazioni a soffitto e a parete

Soffitto
029202

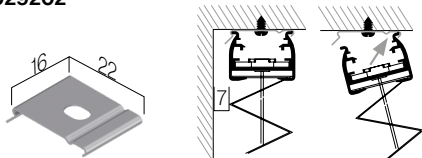

Staffa di separazione
029227

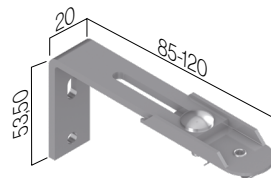

Supporto a parete
029226

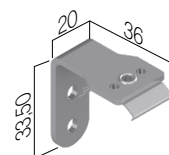

Supporto per tenda in vetro

Supporto superiore

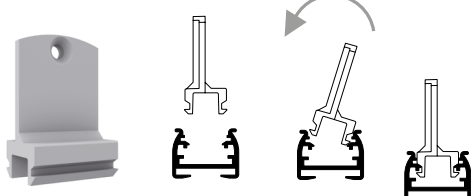

Kit supporto inferiore

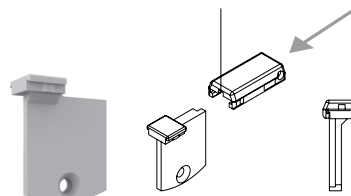

Coperchio di supporto



Versione

Configurazioni

Meccanismo con corda
Con guide laterali (corda).

Meccanismo doppio cavo
Notte/giorno.

Azionamento manuale Con
guide laterali (corda).

Azionamento manuale Chiusura
sopra/sotto e sotto/sopra.
Profilo di montaggio superiore.

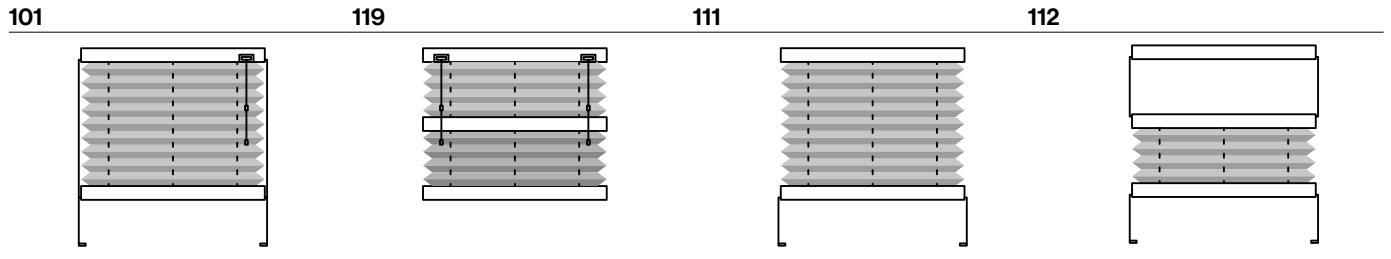

Azionamento manuale
Notte/giorno.

Azionamento manuale Con
profilo di montaggio inferiore.

Azionamento manuale Notte/
giorno con apertura centrale.

Azionamento manuale
Chiusura sopra/sotto
e sotto/sopra, profilo di mon-
taggio superiore e inferiore.

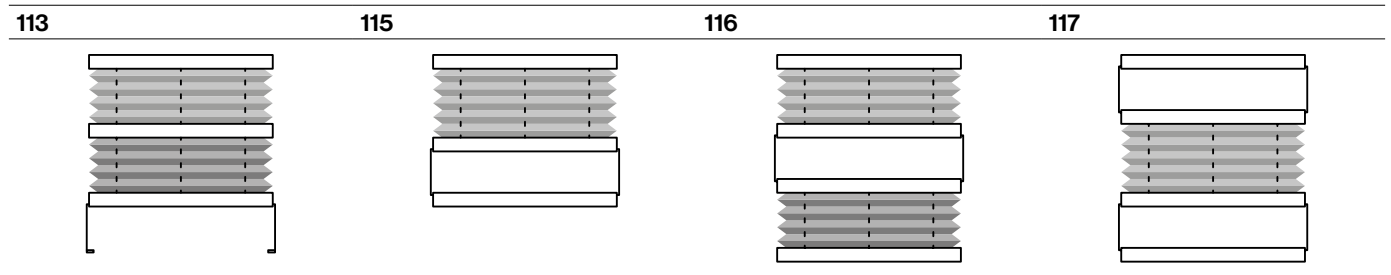

Configurazioni

Azionamento ma-
nuale. Notte/giorno
con profilo di
montaggio inferiore.

Azionamento
manuale. Apertura
centrale.

Azionamento
manuale
Chiusura sopra/so-
ttoe sotto/sopra.

Massimo 1,30
larghezza

Massimo 0,70
larghezza

Massimo 1,30
larghezza

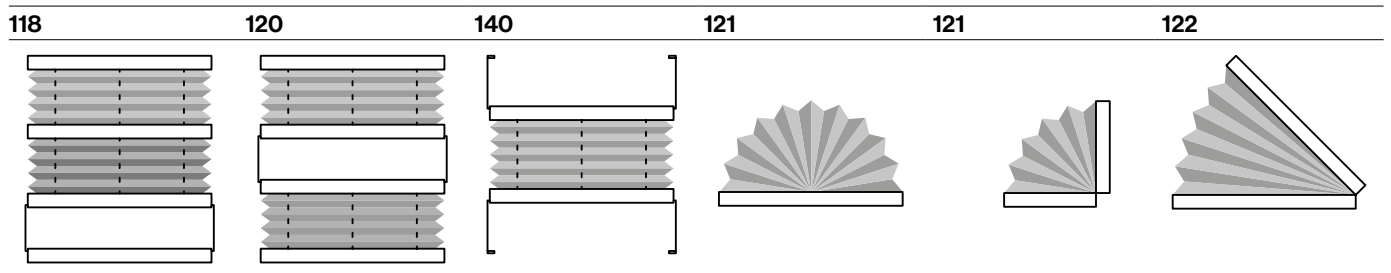

Caratteristiche tecniche

Larghezze massime a seconda del tipo di configurazione

N° configurazione

Larghezza massima

111 • 112 • 113 • 114 • 115 • 116 • 117 • 118 • 119 • 120 • 140

1,20 m

Plisada Glass

029300 Sistema de 20 mm
Configurazione 111 y 140

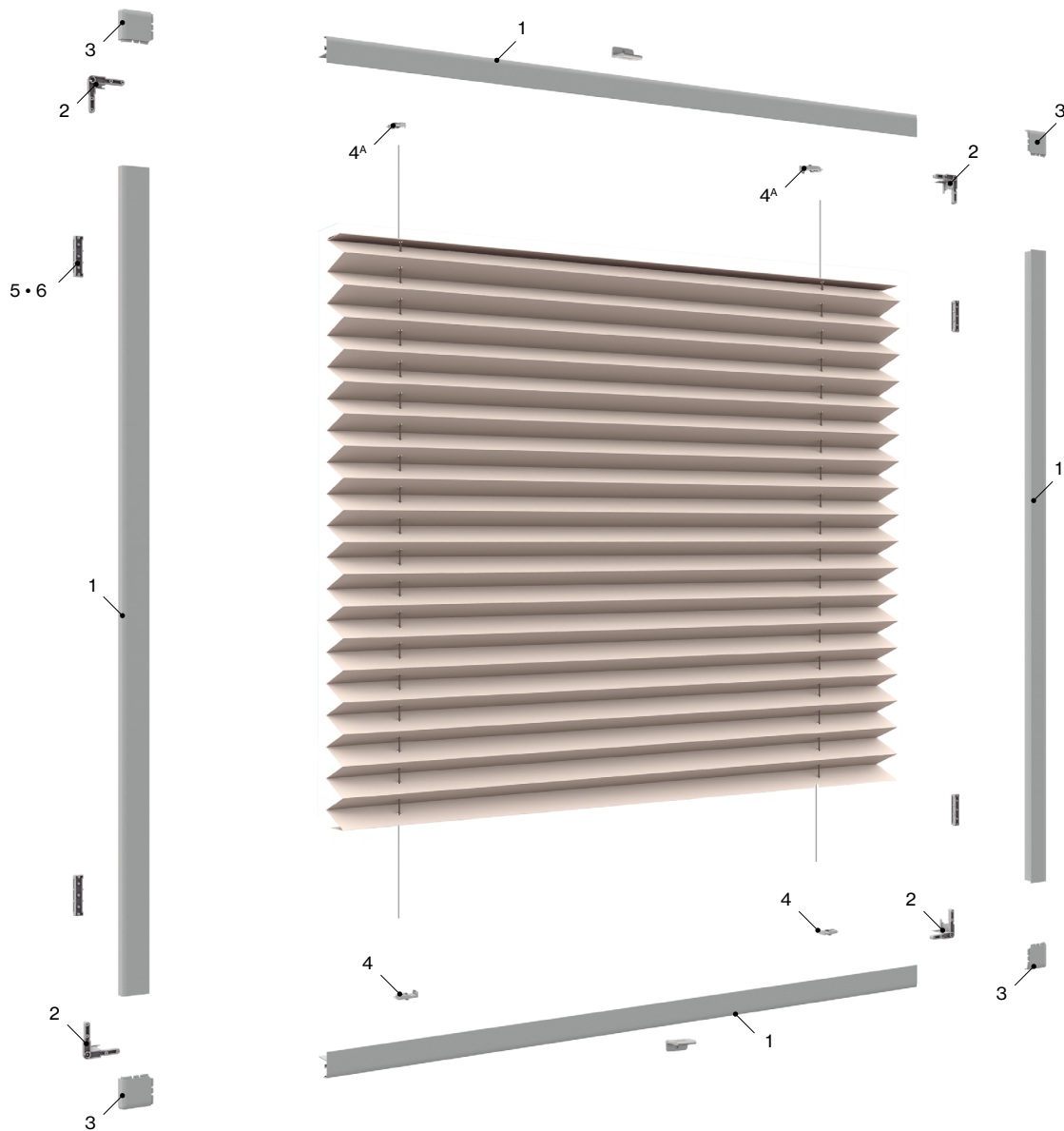

Componenti

N°	Codice	Descrizione	N°	Codice	Descrizione
1	031241	Profilo facile regolazione 580 cm XS	4 ^A	031244	Tension shoe XS (configurazione 140)
2	031242	Unione angolo XS	5	031250	Supporto XS
3	031243	Copertura angolo bianco ABS XS	6	031252	Nastro acrilico schiuma. 10x1,2 mm XS
4	031244	Tension shoe XS			

Misure di produzione

Massimo		Minimo	
Larghezza	1,20 m	Larghezza	0,30 m
Altezza	1,60 m	Altezza	0,30 m

Plisada 27 Especial

029040 Sistema de 27 mm

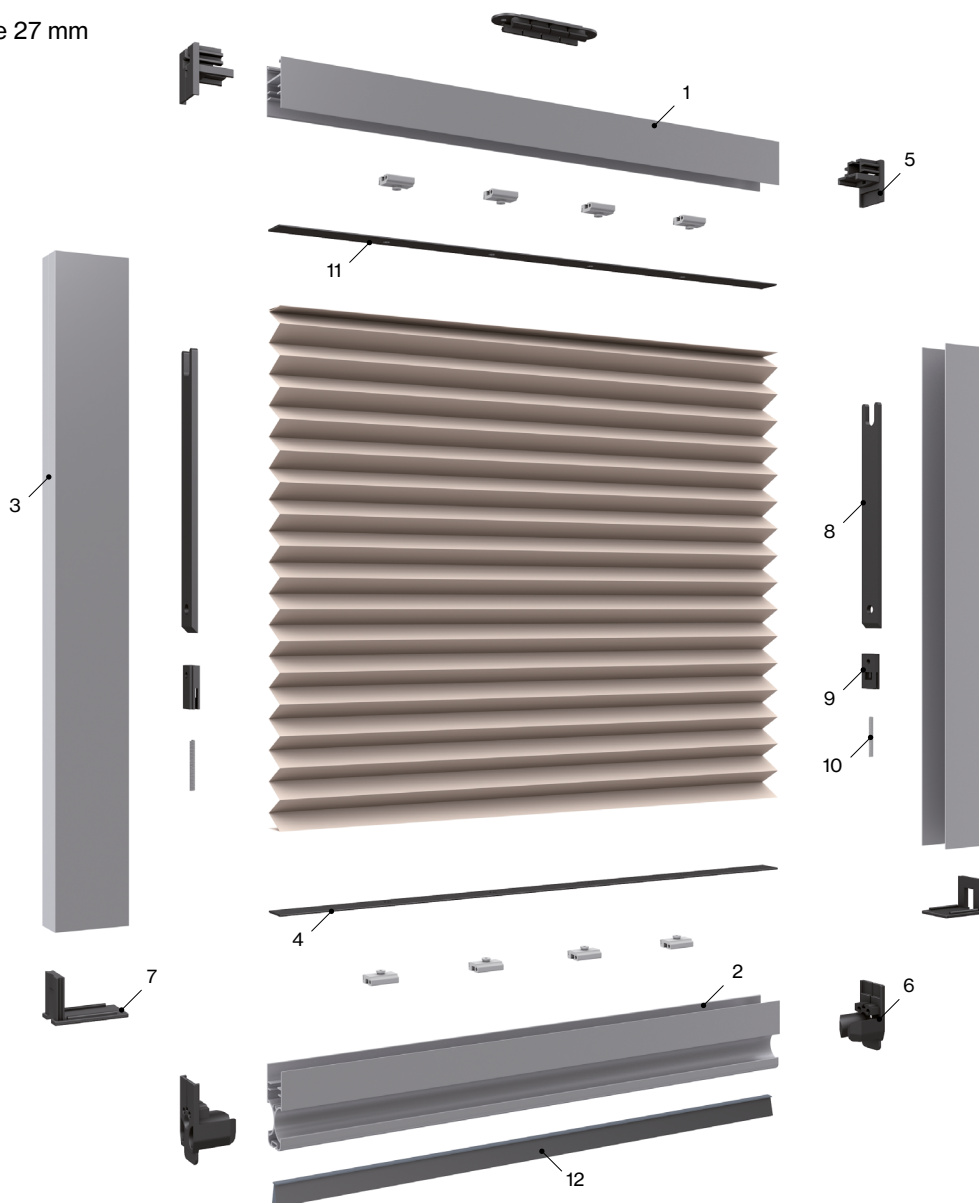

Componenti

N°	Codice	Descrizione	N°	Codice	Descrizione
1	042098	Profilo Fisso 27	8	042126	Fermo testata c/vite Verticale 27
2	042096	Profilo mobile 27	9	042113	Fissaggio filo con dado filettato 27
3	042099	Guida superiore 27	10	042127	Molla 27
4	042082	Profilo PVC fissaggio rete a nastro H260	11	042084	Clip centrale 27
5	042124	Testata superiore profilo fisso 27	12	042805	Spazzolino 58-900
6	042125	Testata superiore profilo parete	13	042023	Supporto zanzariera plissettata
7	042123	Tappo inferiore verticale 27			

Misure di produzione

Massimo		Minimo	
Larghezza	1,60 m	Larghezza	0,40 m
Altezza	2,60 m	Altezza	0,40 m

Caratteristiche tecniche

Profili

Profilo mobile 27
042096

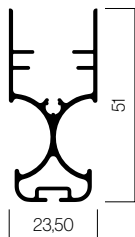

Guida superiore 27
042099

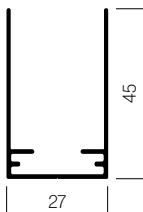

Profilo Fisso 27
042098

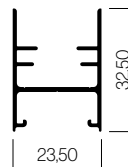

Guida Avant
031241

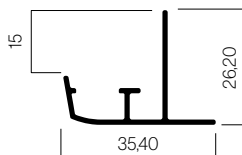

Il tuo mondo,
il nostro universo.

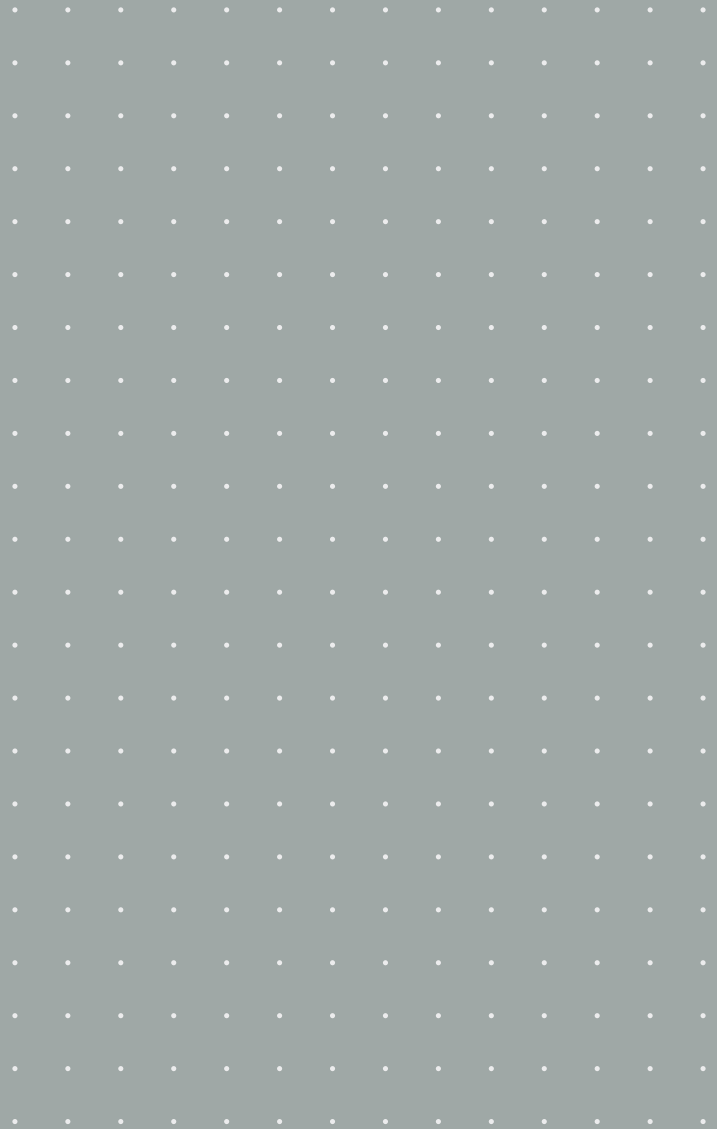

Folha técnica

Plissada



 Modelos

Sistema 20 mm

029001 Sistema de 20 mm

029030 Sistema de 25 mm

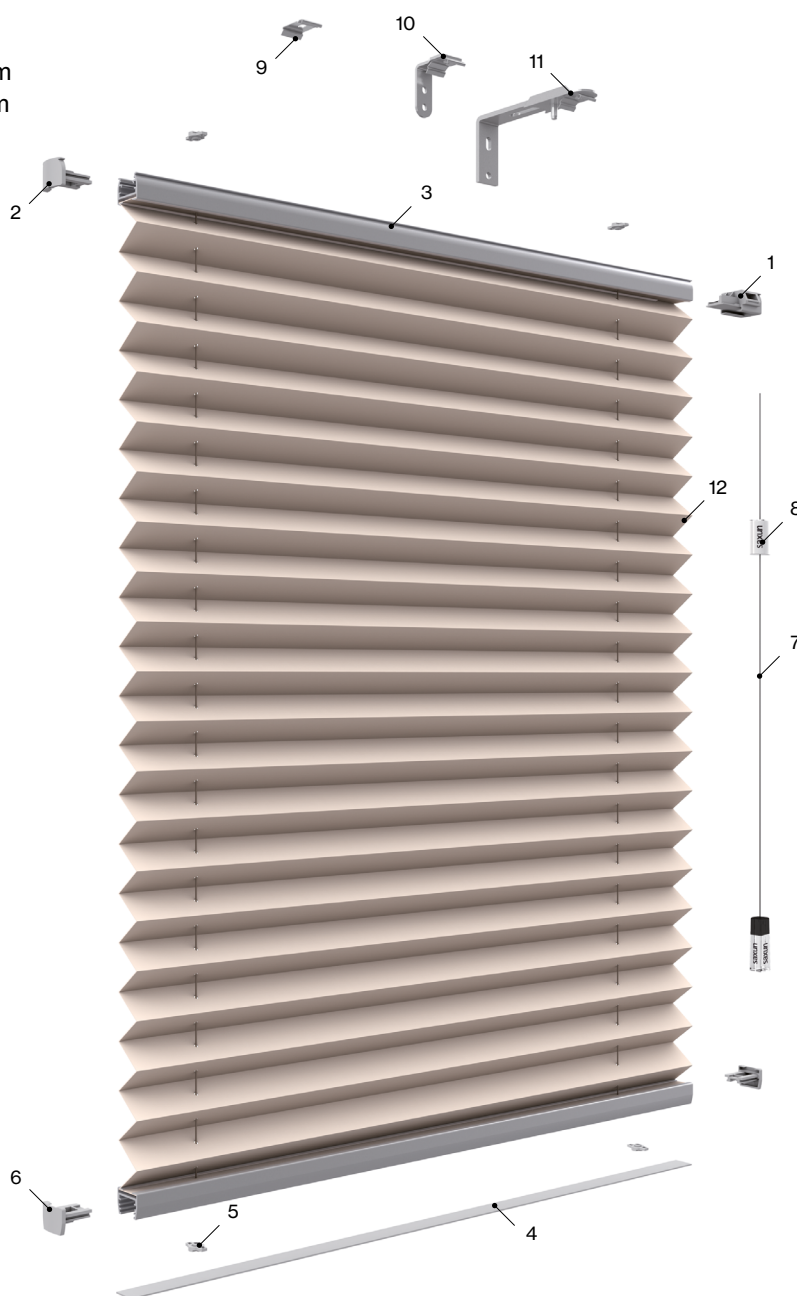

Componentes

Nº	Cód.	Descrição	Nº	Cód.	Descrição
1	029210	Mecanismo Plissada	7	029205	Cordão plissada 1:2
2	029206	Tampão perfil superior	8	029212	Igualador Plissada
3	029217	Perfil alumínio	9	029202	Suporte teto plissada sistema cordão
4	029216	Perfil PVC	10	029226	Esquadro suporte parede Plissada
5	029215	Passador de cordão	11	029227	Esquadro separação Plissada
6	029209	Tampão perfil inferior	12	029203	Cordão Plissada 0,8

Medidas de fabricação

Máximos		Mínimos	
Largura	2,30 m	Largura	0,30 m
Altura	3,00 m	Altura	0,30 m

Tipos de sistemas

Sistema em corrente

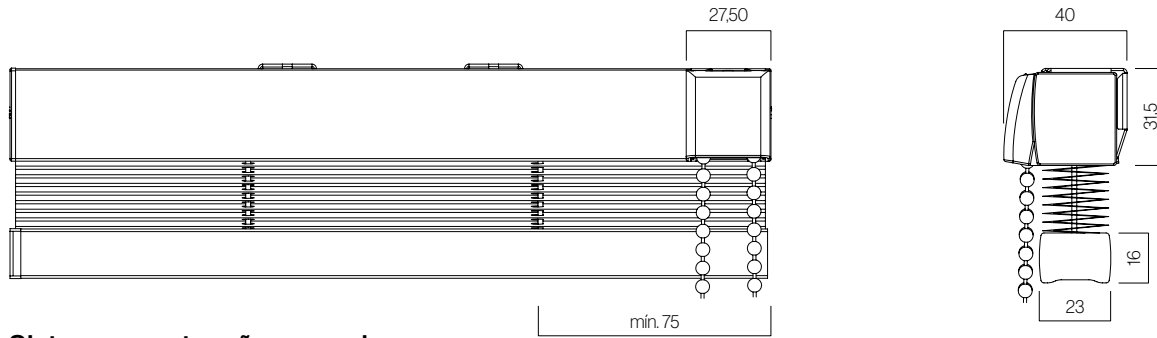

Sistema com tensão manual

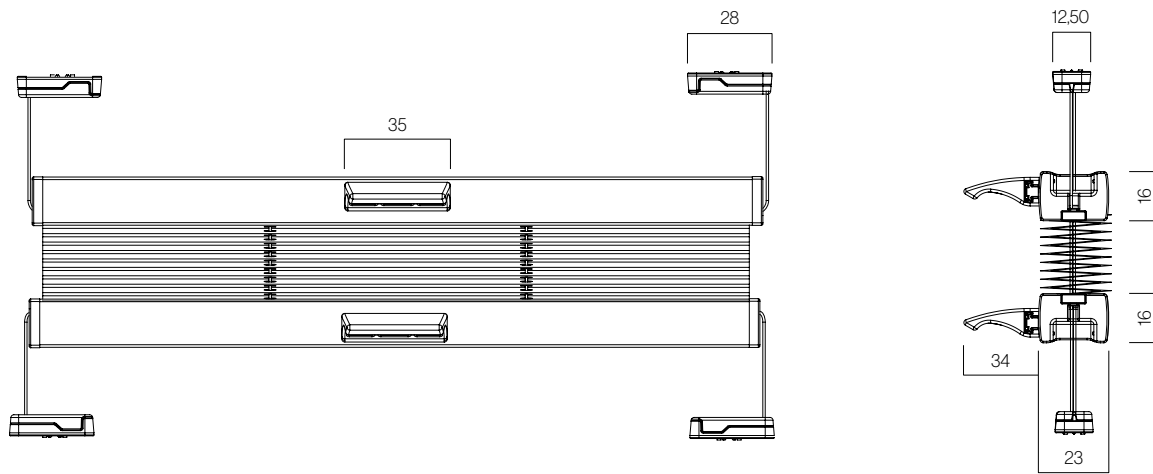

Sistema de corrente

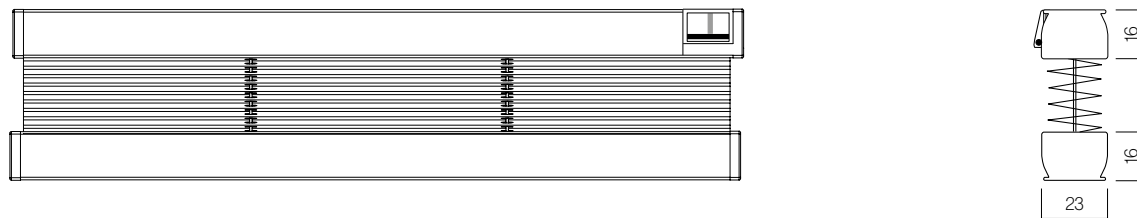

Suportes

Suportes para telhados e paredes

Suporte teto
029202

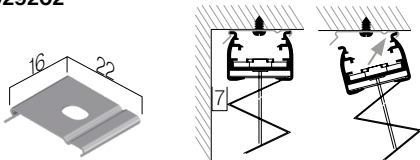

Esquadro separador
029227

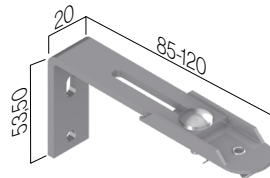

Suporte parede
029226

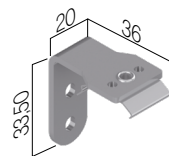

Suporte para cortina de vidro

Suporte superior

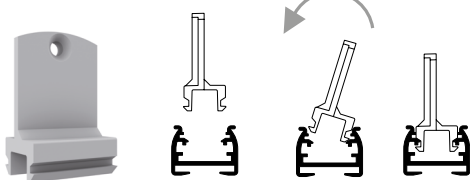

Jgo. suporte inferior

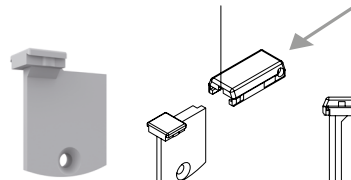

Tampa suporte



Medidas em mm.

Tipos de configuração

Versão

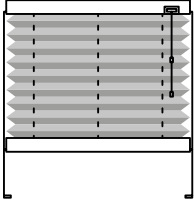
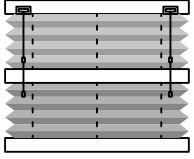
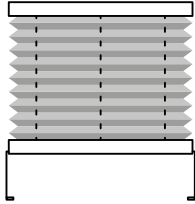
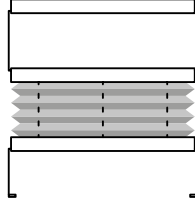
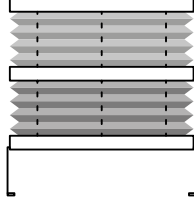
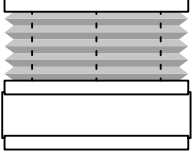
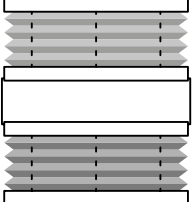
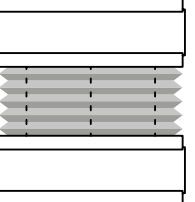
Mecanismo de cordão Com guias laterais (cordão).	Mecanismo duplo cordão. Noite/dia.	Acionamento manual Com guias laterais (cordão).	Acionamento manual Fecho acima/abaixo e abaixo/acima. Perfil de montagem superior.
101	119	111	112
			
Acionamento manual Noite/dia.	Acionamento manual Com perfil de montagem inferior.	Acionamento manual Noite/ dia com abertura central.	Acionamento manual Fecho acima/abaixo e abaixo/acima. Perfil de montagem superior e inferior.
113	115	116	117
			

Versão

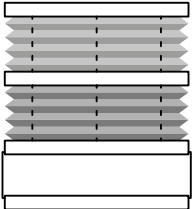
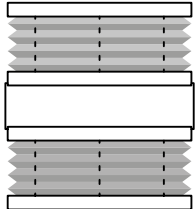
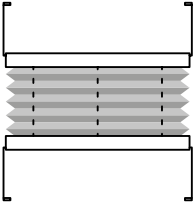
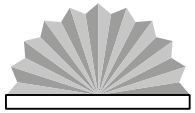
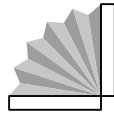
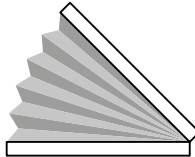
Acionamento ma- nual. Noite/dia com perfil de montagem inferior.	Acionamento manual. Abertura central.	Acionamento manual. Fecho acima/abaixo e abaixo/acima.	Máximo 1,30 largura	Máximo 0,70 largura	Máximo 1,30 largura
118	120	140	121	121	122
					

Características técnicas

Largura máxima de acordo com o tipo de configuração

Nº configuração	Largura máxima
111 • 112 • 113 • 114 • 115 • 116 • 117 • 118 • 119 • 120 • 140	1,20 m

 Modelos

Plisada Glass

029300 Sistema de 20 mm
Configuração 111 e 140

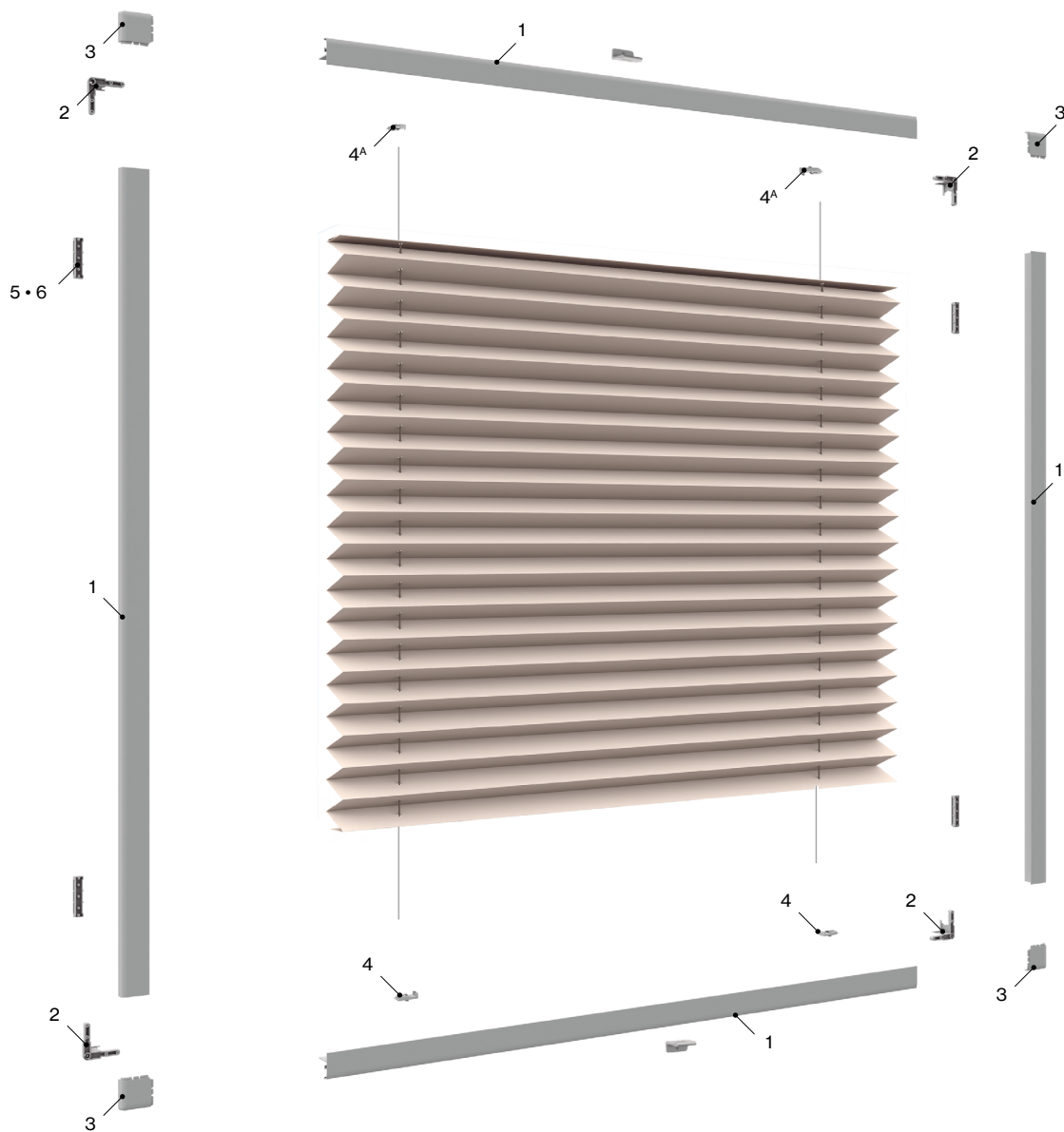

Componentes

Nº	Cód.	Descrição	Nº	Cód.	Descrição
1	031241	Perfil fácil de ajuste 580 cm XS	4 ^A	031244	Tensão Shoe XS (configuração 140)
2	031242	Junção canto XS	5	031250	Suporte para XS
3	031243	Tampa canto branco ABS XS	6	031252	Fita de espuma acril. 10x1,2 mm XS
4	031244	Tensão Shoe XS			

Medidas de fabricação

Máximos		Mínimos	
Largura	1,20 m	Largura	0,30 m
Altura	1,60 m	Altura	0,30 m

 Modelos

Plisada 27 Especial

029040 Sistema de 27 mm

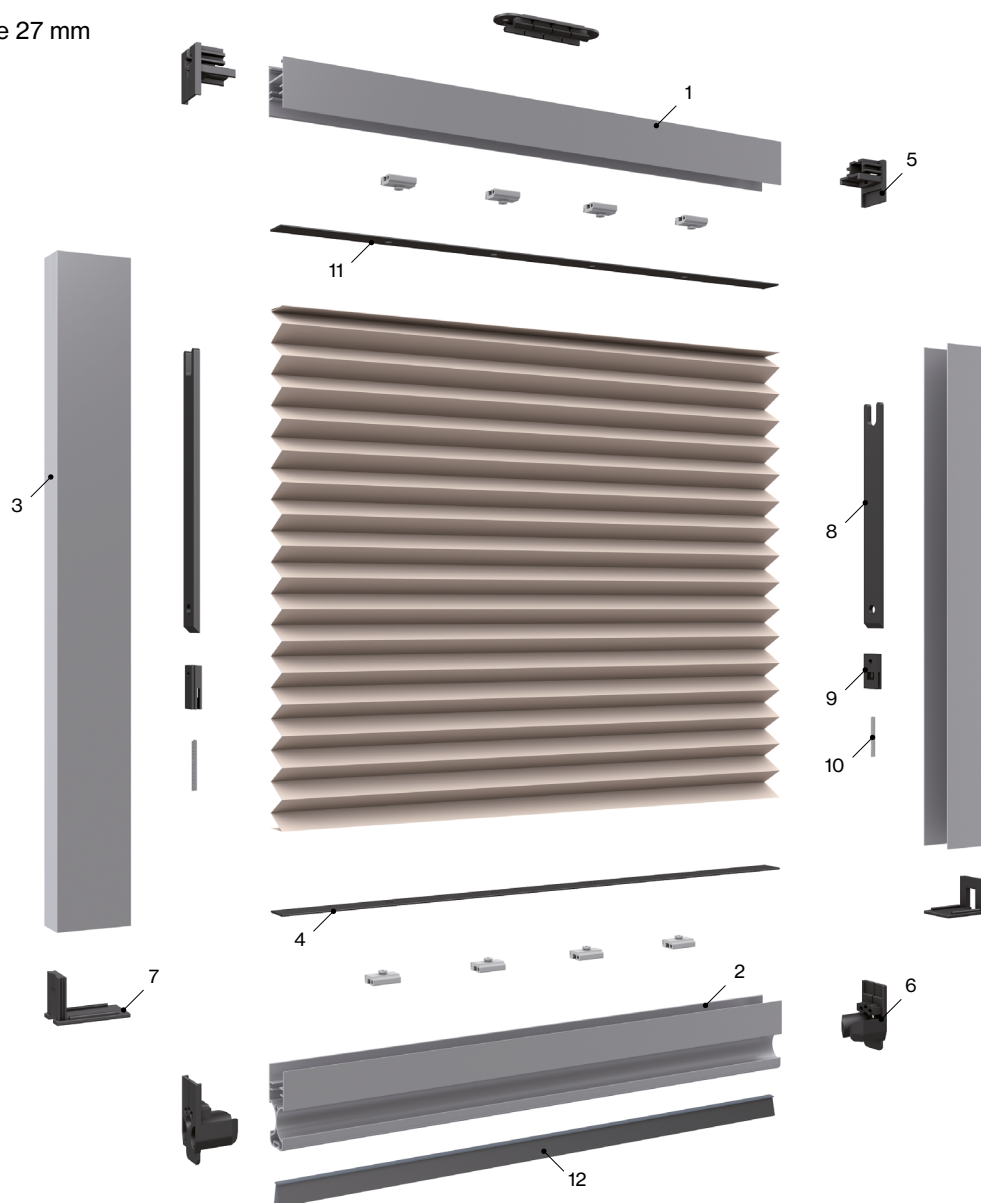

Componentes

Nº	Cód.	Descrição	Nº	Cód.	Descrição
1	042098	Perfil fixo 27	8	042126	Topo testeiro c/parafuso Vertical 27
2	042096	Perfil móvel 27	9	042113	Fixação fio com porca de rebite 27
3	042099	Guia superior 27	10	042127	Mola 27
4	042082	Tira PVC fixação rede H260	11	042084	Clip central 27
5	042124	Testeiro superior perfil fixo 27	12	042805	Tapete 58-900
6	042125	Testeiro superior perfil parede	13	042023	Suporte mosquiteira plissada
7	042123	Tampa inferior Vertical 27			

Medidas de fabricação

Máximos		Mínimos	
Largura	1,60 m	Largura	0,40 m
Altura	2,60 m	Altura	0,40 m

Características técnicas

Perfis

Perfil móvel 27
042096

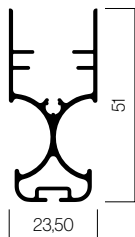

Guia superior 27
042099

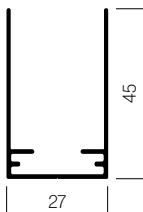

Perfil fixo 27
042098

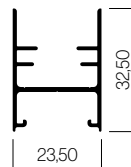

Guia Avant
031241

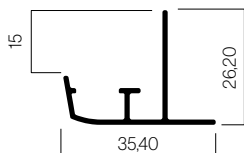

O seu mundo,
o nosso universo.