

# Outdoor Gel Dispensers



Range of mobile self-supporting gel dispensers made from matt silver anodized aluminum. Available in a version with support for glove box or disposable tissues and / or bin holder ring, they are ideal for placing at entrances to public establishments, offices, cinemas, shopping centers, etc ... Clean with a damp cloth and a neutral detergent type window cleaner. Dry with a dry cloth.

Gama de dispensadores de gel autoportantes móviles fabricados en aluminio anodizado plata mate. Disponibles en versión con soporte para caja de guantes o pañuelos desechables y/o aro porta papelera, son ideales para ubicar en entradas de establecimientos, oficinas, cines, centros comerciales, etc... Limpiar con un paño húmedo y detergente neutro tipo limpiacristales. Secar con un paño seco.

*Gamme de distributeurs de gel auto-portants mobiles en aluminium anodisé argent mat. Disponibles en version avec support pour boîte à gants ou mouchoirs jetables et / ou anneau porte-poubelle. Ils sont idéaux pour être placés à l'entrée d'établissements publics, bureaux, cinémas, centres commerciaux, etc... Nettoyer avec un chiffon humide et une vitre de type détergent neutre nettoyeur. Sécher avec un chiffon sec.*



# Outdoor Gel Dispensers

## EP/SOP/IGP



## EP/SOP/IGG



## Size

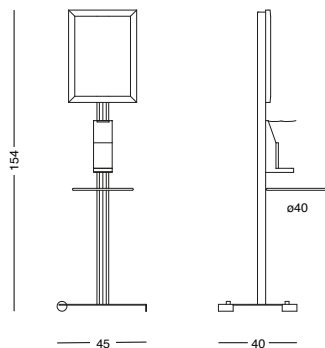

## Size

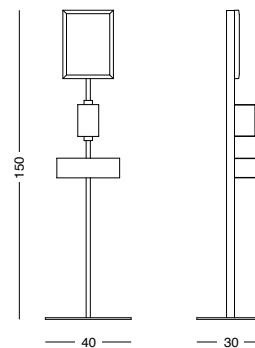

## Data

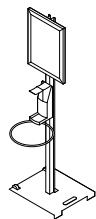

## Data

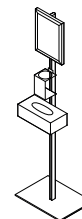

REF	↕ ↔	↗ ↖	⚖
EP/SOP/IGP	154x45 cm 60.6x17.7 in	40 cm 15.7 in	13 Kg 28.6 £

REF	↕ ↔	↗ ↖	⚖
EP/SOP/IGG	150x40 cm 59x15.7 in	30 cm 11.8 in	10 Kg 22 £

\*  
Bottle included (1L) / Gel not included  
Botella incluida (1L) / Gel no incluido  
Bouteille inclus (1L) / Gel non inclus

\*  
Bottle with gel not included  
Botella con gel no incluido  
Bouteille avec gel non inclus

# EP/SOP/IGP + EP/SOP/IGG + EP/SOP/DG

## EP/SOP/DG



### Size

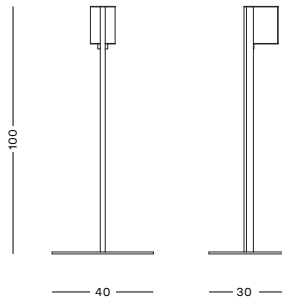

### Data

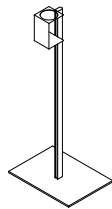

REF	↕ ↔	↗ ↖	👤
EP/SOP/DG	100x40 cm 39.3x15.7 in	30 cm 11.8 in	7 kg 15.4 lb

\*  
Bottle with gel not included  
Botella con gel no incluido  
Bouteille avec gel non inclus

## EP/SOP/M



### Size

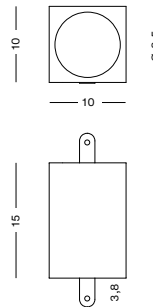

### Data

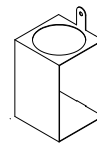

①

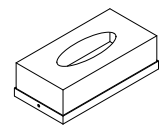
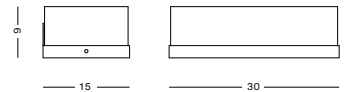

②

REF	↕ ↔	↗ ↖	👤
① EP/SOP/M	15x10 cm 5.9x 3.9 in	10 cm 3.9 in	0,7 kg 1.5 lb
② EP/SOP/GM	9x30 cm 3.5x11.8 in	15 cm 5.9 in	1,4 kg 3 lb

\*  
Bottle with gel and gloves not included  
Botella de gel y guantes no incluida  
Bouteille avec gel et gants non inclus