

**MONTAGE**  
**ASSEMBLING**  
**MONTAJE**

www.sokoa.com

CONFORME NORME EN1335-1-2-3  
COMPLIANT WITH EN1335-1-2-3

**CP SY SELF** YNOTM.089 3.0

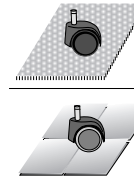
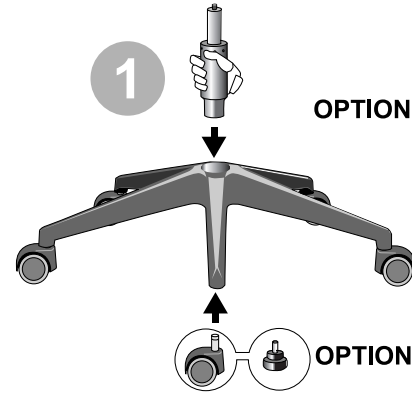

**SOL TEXTILE**  
TEXTILE FLOOR

**SOL DUR**  
HARD FLOOR

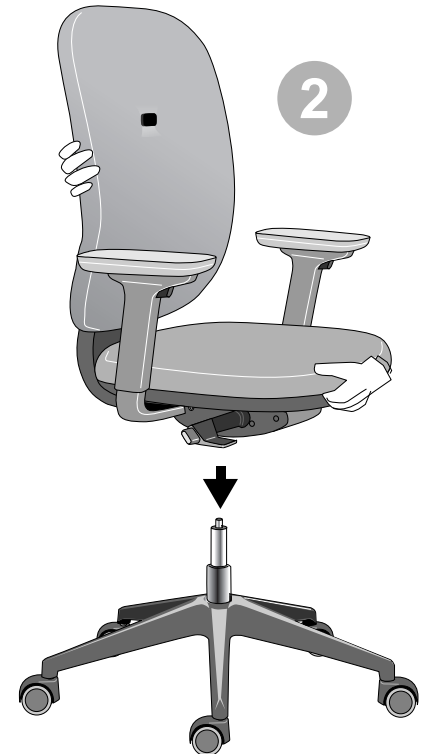

CP

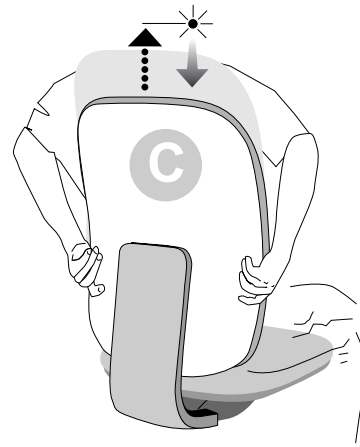
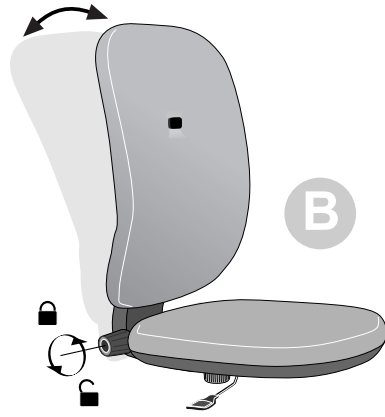
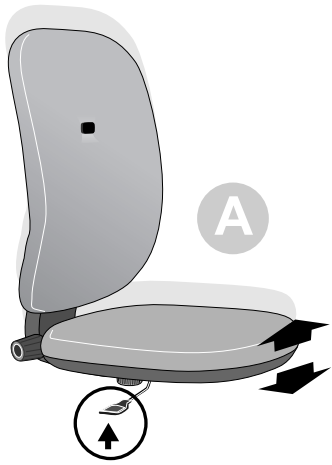

IA+IR

UTILISATION  
USE  
UTILIZACION

SY

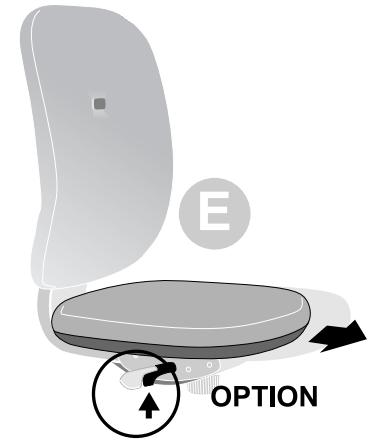
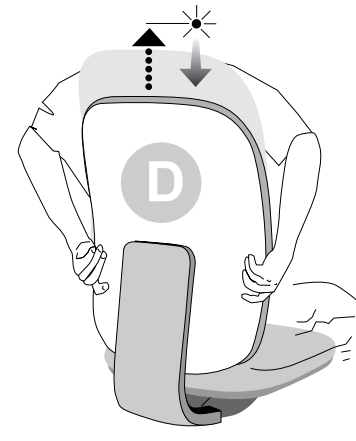
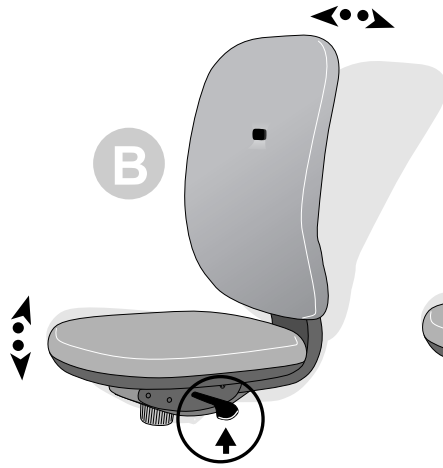

SELF

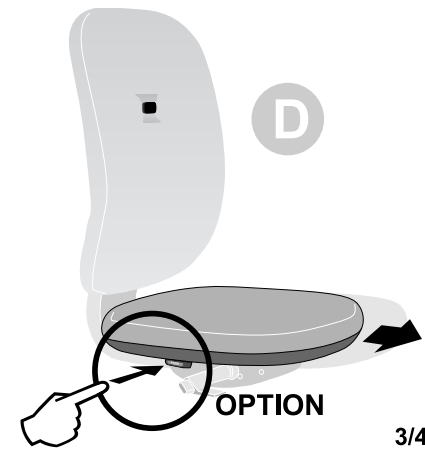
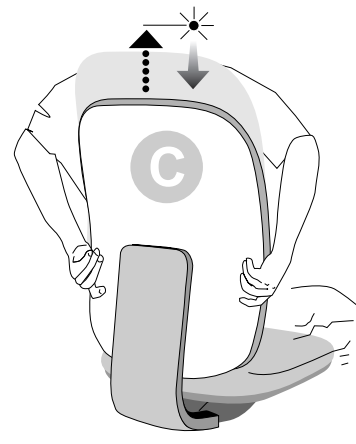
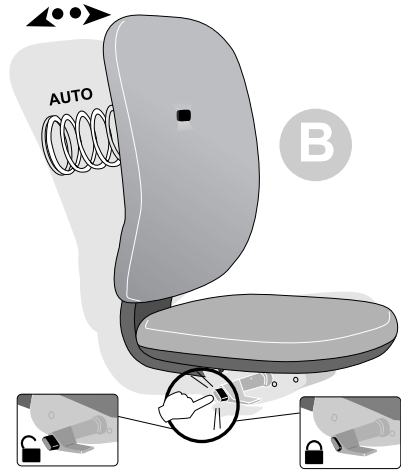
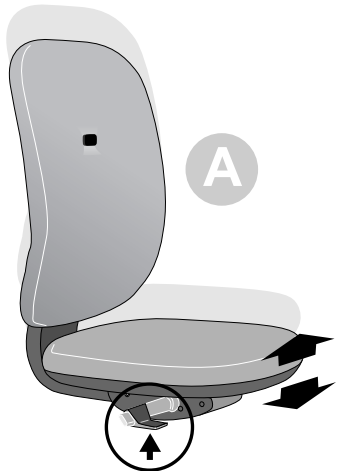



# IA+IR-Bras

YNOTB.037  
v.2.0

MONTAGE - ASSEMBLING - MONTAJE

 x 6

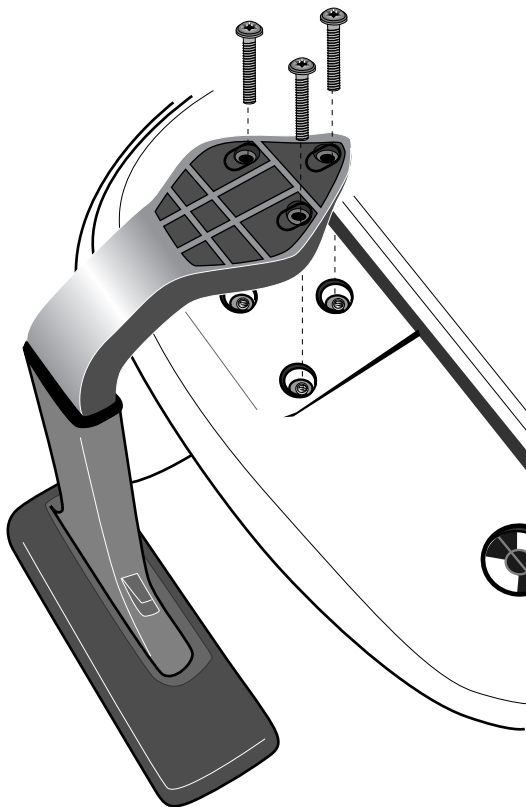
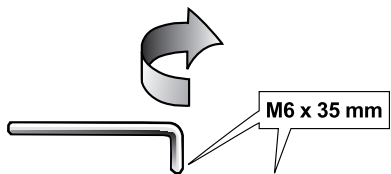

1D



3D

